

Transmission Performance Analysis of Long-Haul WDM Network Employing Single Mode Fiber, Dispersion Compensating Fiber and Erbium Doped Fiber Amplifier

Mohammad Nasir Uddin and Ashim Kumar Saha

Abstract— The performance of Erbium Doped Fiber Amplifier (EDFA), Single Mode Fiber (SMF) and Dispersion Compensating Fiber (DCF) in a dynamic and reconfigurable Wavelength Division Multiplexing (WDM) system has been demonstrated in this simulation study. Eight WDM channels, each channel running at 40 Gbps, are transmitted through SMF, DCF and EDFAs. The effect of long distance transmission of optical signals to the value of OSNR, Q factor and bit error rate (BER) performance in the WDM optical network, keeping the Bit Error Rate (BER) or eye pattern in acceptable range has been observed. The WDM system trial using EDFA's, SMF and DCF shows acceptable but deteriorated eye patterns and bit error penalties upto 420 km of transmission distance. Output power of the system was kept almost constant (-12 dBm) for the whole simulation process. Our simulation model can inhibit dispersion to a minimum possible limit due to the application of DCF (dispersion value is -85 ps/nm/km) along with the single mode fiber (dispersion value is 17 ps/nm/km). Gain flatness is also maintained by keeping the value of input power and output power equal while performance of the network is analyzed.

Keywords- Optical Communication, WDM, EDFA, SMF, DCF

I. INTRODUCTION

Fiber optic technology has been opted to fulfill the requirement for wide band transmission. Optical fibers are being installed where a single fiber has the ability to carry information as much as 200 times faster than was possible just few years ago. This revolutionary capability is being achieved with technology known as Wavelength Division Multiplexing (WDM). WDM technology relies on the fact that optical fibers can carry many wavelengths of light simultaneously without interaction between each wavelength. Thus, a single fiber can carry many separate wavelength signals or channels simultaneously. The communications industry is at the onset of new expansion of WDM technology necessary to meet the new demand for bandwidth. Introducing wavelength division multiplexing (WDM) into the fiber optic technology has made it the transmission medium without limits that offers advantages including higher capacity and speed, ability for transmitting long distance data, any type of optical signal transmission capability, quick and easy deployment, wavelength dependent routing and better signal quality. For

optical network to transmit data, amplifier is an important component that plays a vital role. Erbium Doped Fiber Amplifier (EDFA) can guarantee the signals transmission in long distance range, which functions at windows *C band* and *L band*, was introduced in the early 21st century. It operated in full optical domain and has been replacing the use of repeaters in today's optical communications network [1]. EDFAs are widely used in WDM system for amplification of optical signals. Erbium is a rare earth element that emits light around 1550 nm region when it is excited [2]. EDFA provides wide gain bandwidth at 1550 nm in the low loss window of silicon fiber [3]. Thus it is most suited for WDM operations as WDM also makes use of 1550 nm window. With the increasing demand for high speed and long haul WDM network, researchers are working to increase the performance of all optical long haul WDM transmission system. The maximum transmission distance that can be achievable is an important factor for all future optical networks. In order to optimize the system performance of high speed optical network trade-offs must be made between data rate per channel, channel spacing, optical power, and modulation scheme [4] and for wide band WDM systems, the use of gain equalizing is essential to equalize both the signal power of multiple channels [5]. For high speed optical network very high stability of wavelength and high performance dispersion management is also required [6]. Among all the most fundamental reason that restrict the transmission of high speed signals on the 1550 nm optical fiber is the linear dispersion [7]. Our simulation model can inhibit dispersion to a minimum possible limit and gain flatness is maintained while performance of the network is analyzed. Output power of the system was kept almost constant for the whole simulation process. The maximum distance that can be achievable is simulated for high speed (40 Gbps) all optical network without any Optical-Electrical-Optical (O-E-O) conversion. The bit error rate is also observed with the eye pattern for each of the channels. The basic principle of WDM network has been presented in section II. Complete 8 channels, 40 Gbps WDM network with the explanation of its necessary components have been presented in section III. Simulation and results of this work has been presented in section IV. Finally conclusions are presented in section V.

Mohammad Nasir Uddin is a Lecturer of EEE of Engineering Faculty, American International University - Bangladesh (AIUB), Banani, Dhaka 1213, Bangladesh. E-mail nasiruddin@aiub.edu

Ashim Kumar Saha is an Assistant Professor of EEE of Engineering Faculty, American International University - Bangladesh (AIUB), Banani, Dhaka 1213, Bangladesh. E-mail ashimbitk@yahoo.com

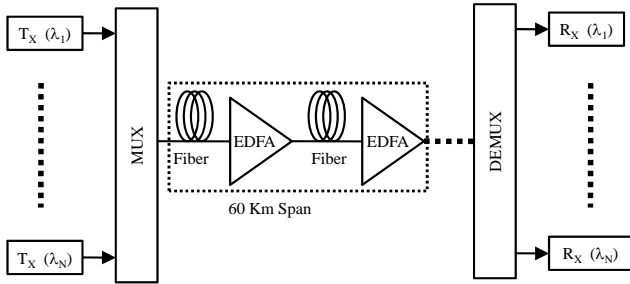

Figure 1: Block diagram of N-channel WDM optical network.

II. THE BASIC PRINCIPLES OF WDM SYSTEM

WDM technology is to make full use of huge bandwidth resources from low loss single mode fiber. According to the difference of each channel wave frequency (or wavelength), the low loss optical window can be divided into several channels. The light waves act as a signal carrier, in the sending end the use of Wavelength Division Multiplexer (MUX) to different provisions of the signal wavelength carrier merged into a single fiber for transmission. At the receiving end these different wavelengths of light signals carrying different carriers are separated by the Wavelength Division Demultiplexer (DEMUX). Different wavelengths of light carrier signal can be seen as independent of each other (without regard to fiber nonlinear time). The block diagram of WDM system is shown in Figure 1.

III. THE 8 CHANNEL, 40 GBPS WDM SYSTEM

An optical communication system consists of transmitter, communication channel and receiver. The role of the optical transmitter is to convert the electrical signal into optical form and launch the resulting optical signal into the optical fiber. Optical signals were transmitted through optical fiber to the optical receiver, and then the optical receiver converted the distorted and attenuated weak optical signal output from the fiber optic lines to electrical signals, enlarged and processed into the pre-launch signal, thus the entire transmission process was completed.

A. Transmitter

Optical transmitter is one of the core equipment of fiber optic transmission system and consists of optical pulse generator and optical modulator [8]. In this work, WDM transmitter consists of 8 ports, Externally Modulated Laser (EML) scheme, frequency of the first channel is 190 THz, frequency spacing between channels is 200 GHz, channel output power of -8.8 dBm and extinction ratio of 30 dB with Non Return to Zero (NRZ) modulation scheme has been used. For high speed (40Gbps) WDM network, the adoption of the Directly Modulated Laser (DML) scheme makes optical pulse waveform deterioration in long distance transmission due to frequency chirp added to fiber dispersion [9], whereas the high performance EML has an advantage of no laser chirp, low

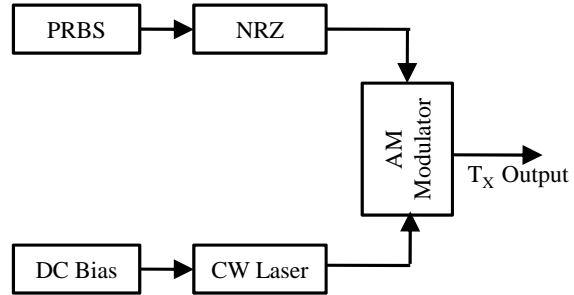

Figure 2: Internal blocks of EML WDM transmitter.

dispersion distortion and high extinction ratio and widely available. The transmitter can be followed by amplifier (EDFA). Internal structure of the optical transmitter $T_X(\lambda)$ used in this work is shown in Figure 2.

B. Transmission line

Single Mode Fiber (SMF) is applicable for high capacity, long distance optical fiber communications due to its tremendous bandwidth. The WDM transmission line span consists of two EDFAs, 50 km SMF and 10 km Dispersion Compensation Fiber (DCF). Dispersion of SMF is 17 ps/nm/km, dispersion slope is 0.075 ps/nm²/km, reference wavelength is 1571.5 nm, attenuation 0.2 dB/Km. Reference wavelength of DCF is 1571.5 nm, attenuation 0.2 dB/km, dispersion -85 ps/nm/km, dispersion slope -0.3 ps/nm²/km. The most fundamental reason that restricts the transmission of high speed signals on the 1550 nm optical fiber is the linear dispersion [7]. So to minimize the dispersion, DCF of 10 km length is taken after careful calculation. However, for the larger attenuation of DFC, EDFA was added after the DCF. An EDFA of 10 dB gain, noise center frequency of 190.7 THz, noise bandwidth of 4 THz and noise figure of 6 dB has been used after SMF to compensate the loss of SMF. Another EDFA with the same parameters as mentioned before except the gain of 5 dB has also been used after the DCF to compensate the loss of DCF. Group velocity dispersion, the third order dispersion, self phase modulation effect has also been considered for DCF and SMF with a differential group delay of 0.2 ps/km.

C. Receiver

Optical receiver is composed of the photoelectric detectors and filters. Performance enhancement of the optical receiver can increase the maximum transmission distance of optical fiber communication system. Optical receivers design to a large extent depends on the modulation technique of the transmitter [7], [10]. In the design of the receiver for this work, PIN detectors and Bessel low-pass filter whose bandwidth is $4 \times$ Bit rate and cut off frequency is $0.75 \times$ Bit rate (30 Gbps) has been selected. Responsivity of 1 A/W, Dark

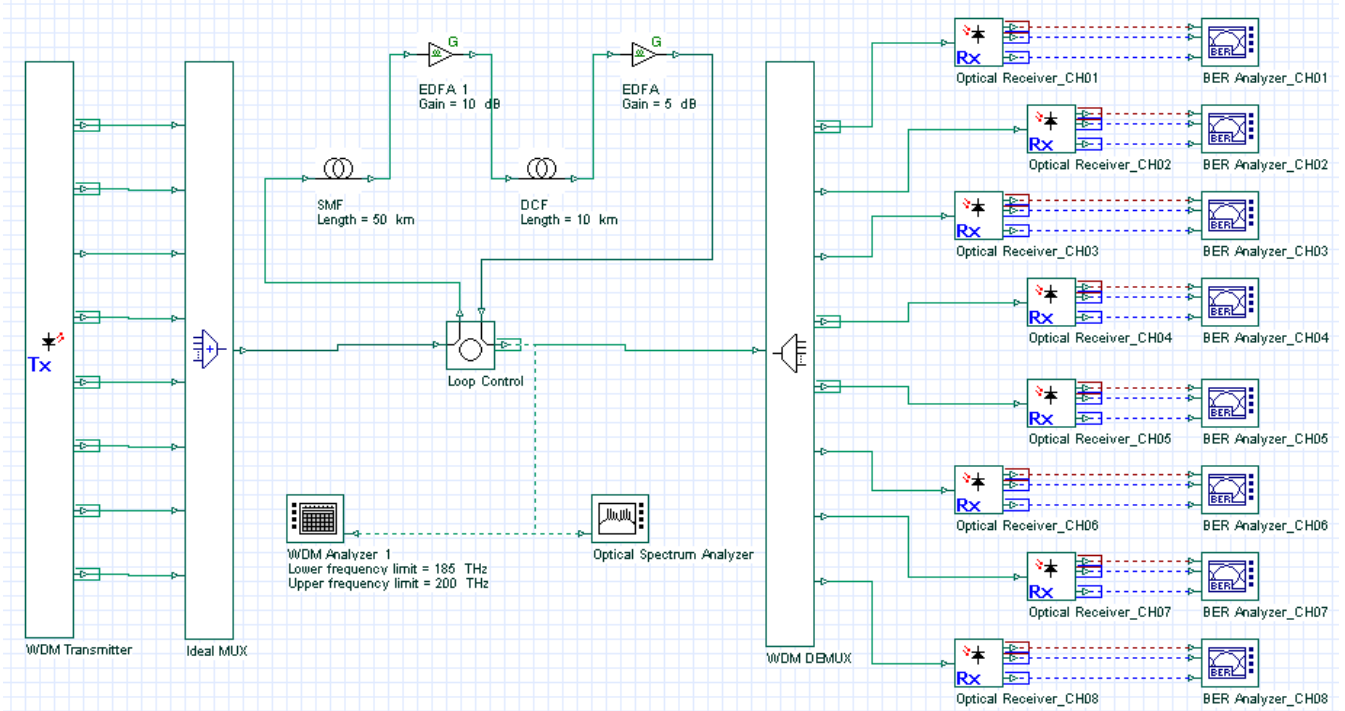

Figure 3: Simulation setup for 8 channel long haul WDM network, employing WDM Transmitter, MUX, SMF, DCF, EDFAs, DEMUX and optical receivers. WDM analyzer, optical spectrum analyzer and BER analyzer have been used to observe the performance of the whole network.

current 10 nA, Signal ASE noise, ASE-ASE noise and shot noise has been taken into account for the PIN detector during simulation. Receiver’s center frequency has been set at maximum power region for corresponding channels.

D. WDM MUX and DEMUX

Multiplexer (MUX) is an optical device and converges all the color rays to combine on one point to make a broadband pulse. Here in 8-channel systems, the 8 colour rays from 8 Transmitters are connected to the appropriate input ports of the MUX and the common single output port is connected to the SMF. The 8 port DEMUX performs the reverse function of MUX. By this unit, the received beam is separated into its wavelength (color) components and coupled them in appropriate ports to the individual fiber.

IV. SIMULATION AND RESULT

Optisystem tool of Optiwave software has been used for the simulation of the network presented in this work. Eight channel long-haul WDM network, employing WDM transmitter, MUX, SMF, DCF, EDFAs, DEMUX, optical receivers and some analyzers is presented in Figure 3. WDM analyzer, optical spectrum analyzer and BER analyzer have been used to observe the operation performance of the whole network. Loop control is used to vary the transmission distance of the network. For the simulation of the WDM

network presented in Figure 3, 60 km segment is taken as span length and transmission distance has been increased in 60 km steps up to 600 km. Signal spectrum, eye-diagram, Bit Error Rate (BER), Optical Signal to Noise Ratio (OSNR) and Q factor for all 8 channels has been observed and presented for different transmission distances. Signal and noise spectrum of the entire 8 channel of the WDM network has been shown in Figure 4. It has been found that the received signal power of

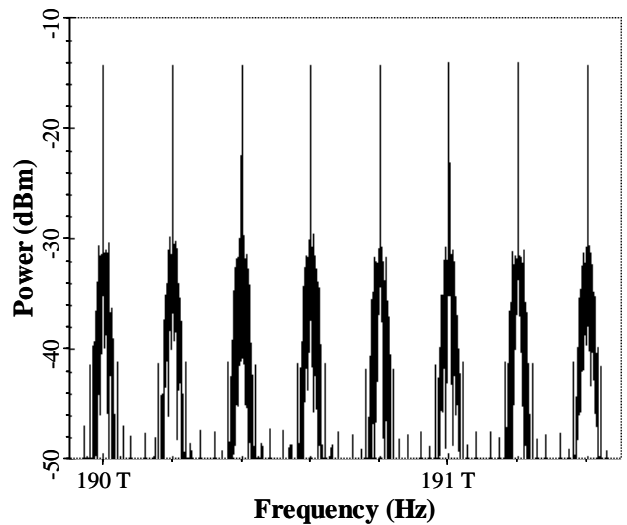

Figure 4: Signal spectrum of all of the channels at the receiving end before the DEMUX. Center frequency of the first channel is at 190 THz and separations of the channels are 0.2 THz.

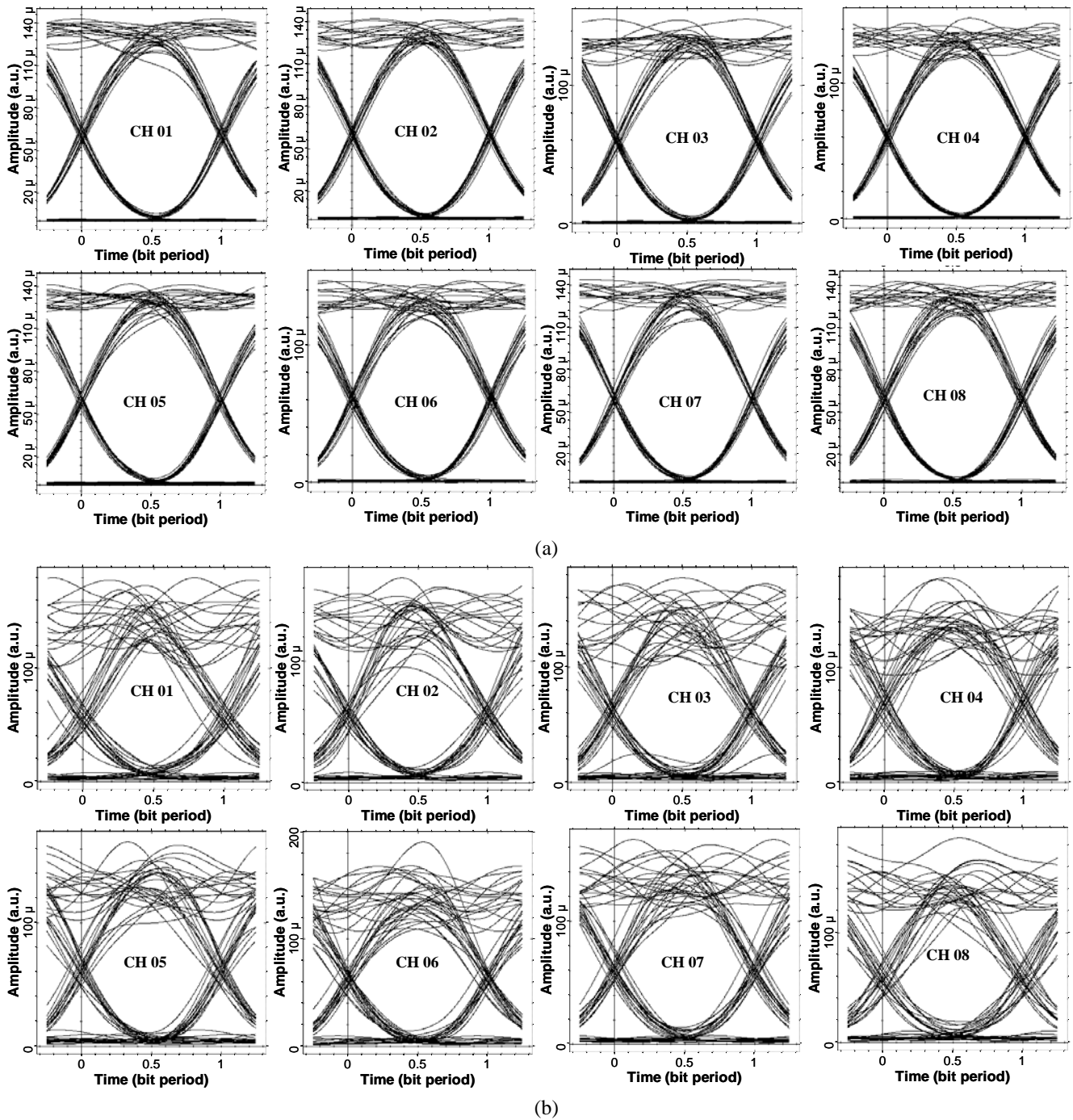

Figure 5: Output eye diagrams of 8 channels, 40 Gbps, WDM optical system for two different transmission distances (a) 60 km and (b) 480 km respectively. Figure (a) shows that data can be received with a minimum MIN BER of 4.60×10^{-115} and maximum MIN BER of 1.04×10^{-64} with a very good eye opening. Figure (a) shows that data can be received with a minimum MIN BER of 1.64×10^{-10} and maximum MIN BER of 4.43×10^{-6} with distorted eye pattern.

all channels remain constant about -14 dBm before the WDM DEMUX. Since gain flattening mechanism has been implemented for this network, received signal power remain constant up to 600 km of transmission distance. However noise power does not remain constant and increases with the increase of the transmission distance. Figure 5 shows the output eye diagram for all the 8 channels observed from the

eye diagram analyzer for a transmission distance of 60 km (Figure 5 a) and 480 km (Figure 5 b). Transmitted data rate has been set at 40 Gbps and NRZ modulation technique has been used. The eye diagrams are very uniform over all eight channels after 60 km of transmission distance demonstrating a robust design of the presented WDM system. After 480 km of transmission the peak to peak jitter increases considerably

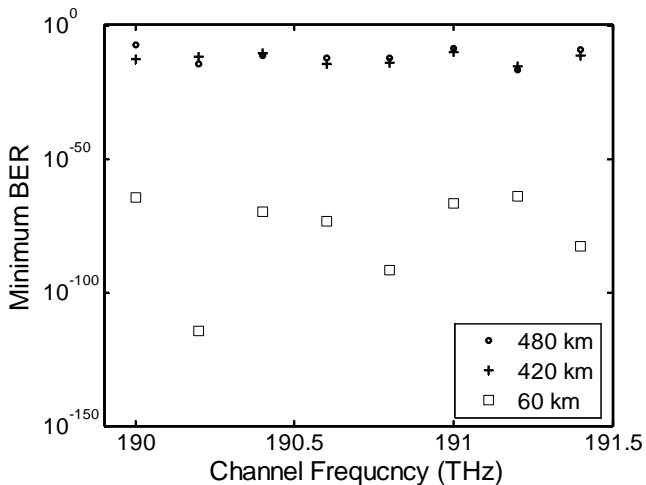

Figure 6: Minimum BER of all 8 channels for 3 different transmission distances 60 km (open squares), 420 km (pluses) and 480 km (open circles).

then the eye diagrams obtained for a distance of 60 km. Minimum BER for the distance of 480 km is not in the acceptable limit but it is in the acceptable limit for a distance of 420 km. Plot of minimum BER versus channel frequency of all 8 channels for the transmission distances of 60 km, 420 km and 480 km are shown in Figure 6. It is found that the minimum BER for all 8 channels are lower than the acceptable BER limit of 10⁻¹². Plot of maximum Q factor versus channel frequency of all eight channels for 60 km, 420 km and 480 km are shown in Figure 7. The values of maximum Q factor for all channels decreases with the increase of transmission distance. It has been found that the value of maximum Q factor for all channels varies with the channel frequency for same transmission distance. It is found that the values of Q factor for all 8 channels for a transmission distance up to 420 km are well above 6.38. For the transmission distance of 480 km it has

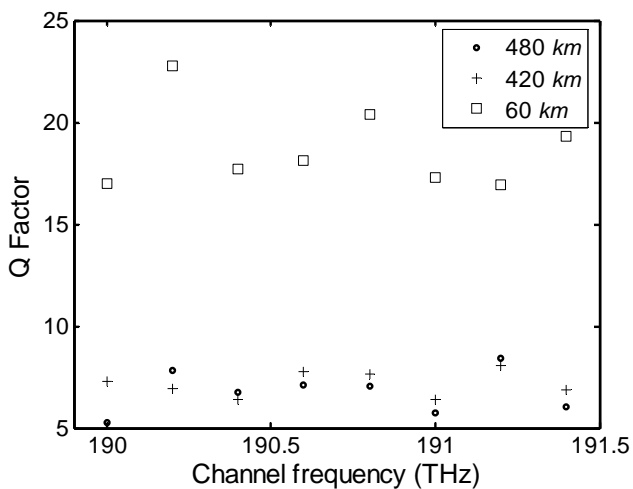

Figure 7: Plot of Q factor of all 8 channels WDM system for 3 different transmission distances 60 km (open squares), 420 km (pluses) and 480 km (open circles).

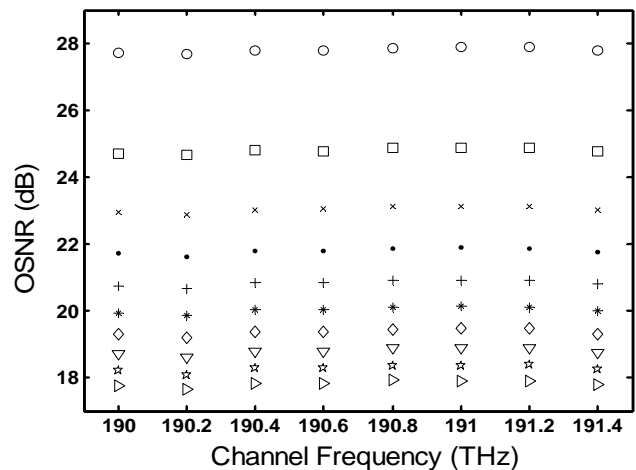

Figure 8: Plot of OSNR versus channel frequency of 8 channels for the transmission distances from 60 km to 600 km with a step of 60 km.

been observed that values of Q factor of channel 1 and channel 6 falls below 6 dB.

OSNR versus channel frequency for all 8 channel of a WDM system for different transmission distances have been shown in Figure 8. Transmission distances from 60 km to 600 km with at step size of 60 km have been considered for the computation of OSNR. It has been observed that the values of OSNR for all channels are decreasing exponentially with the increase of transmission distance. It has also been observed that the OSNR values of all of the channels for a fixed transmission distance remain almost constant due to application of proper OSNR management. Open circles at the upper section of Figure 8 represent the OSNR values of all 8 channels for a transmission distance of 60 km whereas right aligned triangles at the lower section of Figure 8 represent the OSNR values of all 8 channels for a transmission distance of 600 km. Each of the symbols from top (open circle) to bottom (right aligned triangle) corresponding to any channel frequency represent the OSNR values of that channel for the transmission distances from 60 km to 600 km with a step of 60 km. It has been observed that the OSNR values of all channels are below 19 dB for a transmission distance of 480 km where as for a transmission distance of 420 km is above 19 dB which is the acceptable OSNR limit for WDM system [11],[12].

V. CONCLUSION

An eight channel Wavelength Division Multiplexing (WDM) system consisting of Erbium Doped Fiber Amplifier (EDFA), Single Mode Fiber (SMF) and Dispersion Compensating Fiber (DCF) has been presented in this work. Bit rate of each of the channels are set to 40 Gbps and their center frequys are selected from 190 THz to 191.4 THz with a channel spacing

of 200 GHz. It has been found that the average received signal power of all channels remain constant about -13.18 dBm before the WDM DEMUX. Since gain flattening mechanism has been implemented for this network, received signal power remain constant up to 600 km of transmission distance. However noise power does not remain constant and increases with the increase of the transmission distance. After a transmission distance of 420 km, average noise power has been found to be less than -32.54 dBm and average OSNR is 19.36 dB. Whereas for a transmission distance of 480 km, the average OSNR of 18.76 dB and average noise power of -31.96 dBm has been found. Minimum BER for all 8 channels are lower than the acceptable BER limit of 10^{-12} for 420 km of transmission distance. The eye pattern after 480 km of transmission shows considerable amount of jitter and deteriorated eye pattern but for a transmission distance of 420 km acceptable eye pattern has been observed. The values of Q factor for all 8 channels for a transmission distance up to 420 km are well above 6.38. The numerical results show that the maximum transmission distance with acceptable transmission parameters such as minimum BER, OSNR and Q factor is 420 km by employing seven fiber spans.

REFERENCES

- [1] S. Novak, and A. Moesle, "Analytic Model for Gain Modulation in EDFAs" Journal of Lightwave Technology, Vol. 20, Issue 6, pp. 975 – 985, June 2002.
- [2] M. E. Marhic, N. Kagi, T. K. Chiang and L.G. Kazovsky, "Broadband fiber optical parametric amplifiers" OSA Optics Letters, Vol. 21, No 8, pp. 573 - 575, April 1996.
- [3] B. Altiner, N.O. Unverdi, "Modelling - Simulation and gain flattening improvements for an Erbium Doped Fiber Amplifier," Optomechatronic Technologies, 2009. ISOT 2009. International Symposium on, pp. 451-454, 21-23 September 2009.
- [4] E. Tangdiongga, J. J. J. Crijns, L. H. Spiekman, G. N. van den Hoven, and H. de Waardt, "Performance Analysis of Linear Optical Amplifiers in Dynamic WDM Systems" IEEE Photonics Technology Letters, Vol. 14, No. 8, pp. 1196-1198, August 2002.
- [5] S. H. Yun, B. W. Lee, H. K. Kim and B. Y. Kim, "Dynamic Erbium - Doped Fiber Amplifier Based on Active Gain Flattening with Fiber Acoustooptic Tunable Filters" IEEE Photonics Technology Letters, Vol. 11, No. 10, pp. 1229-1231, October 1999.
- [6] G. Yan, Z. Ruixia, D. Weifeng and C. Xiaorong, "Point-to-Point DWDM system design and simulation" Proceeding of the 2009 international symposium on information processing (ISIP'09). Huangshan, P.R. China, pp. 090 – 092, August 2009.
- [7] C. M. Weinert, R. Ludvig, W. Papier, H.G. Weber, D. Breuer, K. Petermann, and F. Kuppers "40 Gbit/s Comparison and 4 X 40 Gbit/s TDM/WDM Standard Fiber Transmission", Journal of Lightwave Technology, Vol. 17, No. 11, pp. 2276 - 2284, November 1999.
- [8] G. P. Agrawal, "Fiber-Optic Communication Systems" John Wiley & Sons Inc., 2003, pp. 13-19.
- [9] Z. Jianzhong. "DWDM optical transmitter design" CATV Technology, No.12, pp 77-81, 2006.
- [10] M. I. Hayee and A. E. Willner, "NRZ Versus RZ in 10-40 Gb/s Dispersion- Managed WDM Transmission Systems" IEEE

Photonics Technology Letters, Vol. 11, pp. 991-993, August 1999.

- [11] K. D. Dambul, F. M. Abbou and H. T. Chuah, "Performance analysis of IP traffic over a WDM ring network in the presence of crosstalk", IEICE Electron. Express, Vol. 2, No. 5, pp.149-153, March 2005.
- [12] S. Nema, A. Goel and R. P. Singh, "Integrated DWDM and MIMO-OFDM System for 4G High Capacity Mobile Communication", Signal Processing: An International Journal, Vol. 3, No. 5, pp. 132-143, February 2005.



Mohammad Nasir Uddin received B.Sc. degree in Electrical and Electronic Engineering from Khulna University of Engineering and Technology, KUET in 2003 and M.Sc Engineering in Computer Networks from Middlesex University, United Kingdom (UK) in 2006. He started his teaching career as a Lecturer of Computer Science & Engineering Department of University of Development Alternative (UODA), Dhanmondi Dhaka, Bangladesh on February 2004. On September 2006, he joined Department of Computing, The Business School of London, United Kingdom (UK) as a Lecturer. He was appointed as a Lecturer of Electrical and Electronic Engineering Department, Faculty of Engineering, American International University-Bangladesh (AIUB) on January 2009. His present research interest includes Wireless Mobile Communication, Fiber optic communication and DWDM system.



Ashim Kumar Saha received B.Sc. degree in Electrical and Electronic Engineering from Khulna University of Engineering and Technology, KUET in 2004 and stood 3rd in order of merit in his class. He started his teaching career as a Lecturer of Computer Science & Engineering Department of University of Development Alternative (UODA) Dhanmondi Dhaka Bangladesh on September 2004. On May 2005, he joined Electrical & Electronic Engineering Department of Engineering Faculty, American International University - Bangladesh (AIUB), Banani, Dhaka as a Lecturer. Since then he has been teaching in the undergraduate classes at AIUB. In April 2008 he became an Assistant Professor of Electrical & Electronic Engineering Department of Engineering Faculty, American International University - Bangladesh (AIUB), Banani Dhaka. Ashim Kumar Saha has been involved in research on Vertical Cavity Surface Emitting Laser (VCSEL) since May 2006. Currently, he is working on Quantum Well and Quantum Dot Lasers.