

# **IOT BASED AGRICULTURAL MONITORING SYSTEM**

An Undergraduate CAPSTONE Project

By

- |                         |                |           |
|-------------------------|----------------|-----------|
| 1. Omer Faruque         | ID: 19-39553-1 | Dept: EEE |
| 2. Raihan Sharif        | ID: 17-34663-2 | Dept: EEE |
| 3. Md Sibbir Khan Tamim | ID: 19-41325-3 | Dept: EEE |
| 4. B.M.ALIF ISHAN       | ID: 20-42700-1 | Dept: EEE |

Under the Supervision of

**Dr. Md Humayun Kabir**  
Associate Professor

**Fall Semester 2022-2023**

**May, 2023**



**Faculty of Engineering**  
**American International University - Bangladesh**

# **IOT Based agricultural monitoring system**

A CAPSTONE Project submitted to the Faculty of Engineering, American International University - Bangladesh (AIUB) in partial fulfillment of the requirements for the degree of Bachelor of Science in their mentioned respective programs.

1. Omer Faruque	ID: 19-39553-1	Dept: EEE
2. Raihan Sharif	ID: 17-34663-2	Dept: EEE
3. Md Sibbir Khan Tamim	ID: 19-41325-3	Dept: EEE
4. B.M.ALIF ISHAN	ID: 20-42700-1	Dept: EEE

**Fall Semester 2022-2023,  
May 2023**



**Faculty of Engineering  
American International University - Bangladesh**

# DECLARATION

This is to certify that this project is our original work. No part of this work has been submitted elsewhere partially or fully for the award of any other degree or diploma. Any material reproduced in this project has been properly acknowledged.

AIUB reserves the right to reuse/update any proprietary material designed and developed for this work.

## Students' names & Signatures

**1. Omer Faruque**

-----

**2. Raihan Sharif**

-----

**3. Md Sibbir Khan Tamim**

-----

**4. B.M.Alif Ishan**

-----

# APPROVAL

The CAPSTONE Project titled **IOT Based agricultural monitoring system** has been submitted to the following respected members of the Board of Examiners of the Faculty of Engineering in partial fulfillment of the requirements for the degree of Bachelor of Science in the respective programs mentioned below on **May 2023** by the following students and has been accepted as satisfactory.

- |                         |                |           |
|-------------------------|----------------|-----------|
| 1. Omer Faruque         | ID: 19-39553-1 | Dept: EEE |
| 2. Raihan Sharif        | ID: 17-34663-2 | Dept: EEE |
| 3. Md Sibbir Khan Tamim | ID: 19-41325-3 | Dept: EEE |
| 4. B.M.ALIF ISHAN       | ID: 20-42700-1 | Dept: EEE |

-----  
Supervisor  
Dr. Md Humayun Kabir  
**Associate Professor**  
Faculty of Engineering  
American International University-  
Bangladesh

-----  
External Supervisor  
Raja Rashidul Hasan  
**Assistant Professor**  
Faculty of Engineering  
American International University-  
Bangladesh

-----  
Prof. Dr. Mohammad Abdul Mannan  
Associate Dean  
Faculty of Engineering  
American International University-  
Bangladesh

-----  
Prof. Dr. ABM Siddique Hossain  
Dean  
Faculty of Engineering  
American International University-  
Bangladesh

-----  
Dr. Carmen Z. Lamagna  
Vice Chancellor  
American International University-Bangladesh

# ACKNOWLEDGEMENT

We would like to express our sincere gratitude and appreciation to the following individuals who have provided invaluable support and guidance throughout the duration of this project:

First and foremost, we would like to extend our heartfelt thanks to our supervisor, Dr. Md Humayun Kabir, for his unwavering support, valuable insights, and continuous guidance. His expertise, patience, and encouragement have been instrumental in shaping the direction of this project and ensuring its successful completion.

We are also grateful to Mr. Raja Rashidul Hasan, our external supervisor, for his valuable inputs, suggestions, and technical expertise. His constructive feedback and guidance have significantly contributed to the overall quality of this work.

We would like to acknowledge the faculty members of the Engineering Department at the American International University-Bangladesh for their dedication and commitment to providing a conducive learning environment. Their expertise and passion for teaching have greatly enriched our understanding of the subject matter.

Additionally, we are grateful to the staff and technicians of the university's engineering laboratories for their assistance and cooperation during the experimental phase of this project. Their expertise and willingness to help have been invaluable.

Last but not least, we would like to thank our families for their unwavering support, love, and encouragement. Their belief in our abilities has been a driving force behind our determination and perseverance. To all those mentioned above and to anyone else who has directly or indirectly contributed to the success of this project, we offer our heartfelt thanks. Your support, guidance, and encouragement have been invaluable, and we are truly grateful for your contributions.

1. Omer Faruque
2. Raihan Sharif
3. Md Sibbir Khan Tamim
4. B.M.ALIF ISHAN

# **TABLE OF CONTENTS**

DECLARATION .....	I
APPROVAL.....	II
ACKNOWLEDGEMENT .....	III
LIST OF FIGURES .....	VI
LIST OF TABLES.....	VIII
ABSTRACT .....	IX
CHAPTER 1 .....	2
INTRODUCTION.....	2
1.1. Overture .....	2
1.2. Engineering Problem Statement .....	3
1.3. Related Research Works.....	3
1.3.1. Earlier Research.....	3
1.3.2. Recent Research .....	7
1.4. Critical Engineering Specialist Knowledge.....	13
1.5. Stakeholders.....	13
1.6. Objective of this Work .....	14
1.6.1. Primary objectives .....	14
1.6.2. Secondary Objectives .....	14
1.7. Organization of Book Chapters .....	15
CHAPTER 2 .....	16
PROJECT MANAGEMENT .....	16
2.1. Introduction .....	16
2.2. S.W.O.T. Analysis of the Project .....	16
2.3. Schedule Management.....	18
2.4. Cost Analysis .....	18
2.5. P.E.S.T. Analysis.....	19
2.6. Professional Responsibilities .....	20
2.6.1. Norms of Engineering Practice.....	20
2.6.2. Individual Responsibilities and Function as effective team member .....	21
2.7. Management principles and economic models.....	22
2.8. Summary.....	22
CHAPTER 3 .....	24
METHODOLOGY AND MODELING .....	24
3.1. Introduction .....	24
3.2. Block Diagram and Working Principle .....	25
3.3. Modeling.....	28
3.4. Summary.....	29
CHAPTER 4 .....	30

PROJECT IMPLEMENTATION .....	30
4.1. Introduction .....	30
4.2. Required Tools and Components .....	30
4.3. Implemented Models .....	31
4.3.1. Simulation Model .....	37
4.3.2. Hardware Model.....	38
4.4. Summary.....	41
CHAPTER 5 .....	42
RESULTS ANALYSIS & CRITICAL DESIGN REVIEW .....	42
5.1. Introduction .....	42
5.2. Results Analysis .....	43
5.2.1. Simulated Results .....	44
5.2.2. Hardware Results.....	45
5.3. Comparison of Results.....	47
5.4. Summary.....	48
CHAPTER 6 .....	50
CONCLUSION .....	50
6.1. Summary of Findings .....	50
6.2. Novelty of the work .....	50
6.3. Cultural and Societal Factors and Impacts .....	51
6.4. Engineering Solution in accordance with professional practices .....	52
6.5. Limitations of the Work .....	52
6.6. Future Scopes .....	53
6.7. Social, Economic, Cultural and Environmental Aspects.....	53
6.7.1. Sustainability .....	54
6.7.2. Economic and Cultural Factors .....	55
6.8. Conclusion.....	55
REFERENCES .....	57
APPENDIX A .....	51
DATASHEET OF THE ICs USED .....	51
APPENDIX B .....	60
I <small>T</small> HENTICATE PLAGIARISM REPORT.....	60

# LIST OF FIGURES

FIGURE 1.1 WIRELESS SENSOR NETWORK, SHOWING SENSOR AND SATELLITE STATION DEPLOYMENT [4].	4
FIGURE 1.2 SYSTEM INFRASTRUCTURES [5]	5
FIGURE 1.3 THE MODULES OF AGRICULTURAL INTELLIGENT SYSTEM [6]	6
FIGURE 1.4 SYSTEM ARCHITECTURE [7]	6
FIGURE 1.5: BLOCK DIAGRAM FOR AUTOMATION IRRIGATION SYSTEM [9]	8
FIGURE 1.6: WIRELESS SENSOR NETWORK LAYOUT FOR AUTOMATED IRRIGATION SYSTEM [10]	10
FIGURE 1.6: WIRELESS SENSOR NETWORK LAYOUT FOR AUTOMATED IRRIGATION SYSTEM [10]	11
FIGURE 1.8: INTELLIGENT WATERING SYSTEM USED IN PRECISION AGRICULTURE [12]	12
FIGURE 4.1: BLOCK DIAGRAM OF THE PROJECT	25
FIGURE 3.2: 3D MODEL OF THE PROJECT	27
FIGURE 4.1: ESP32	31
FIGURE 4.2: 4 CHANNEL RELAY	31
FIGURE 4.3: DHT11	32
FIGURE 4.4: COOLING FAN	33
FIGURE 4.4: RAIN & MOISTURE SENSOR	34
FIGURE 4.5: AIR QUALITY SENSOR	34
FIGURE 4.5: GEAR MOTOR	35



FIGURE 4.6: MOTOR DRIVER.....	36
FIGURE 4.7: PROTEUS SIMULATION .....	38
FIGURE 4.8: HARDWARE MODEL.....	39
FIGURE 5.1: BLYNK APP RESULT.....	45
FIGURE 5.2: BLYNK DESKTOP INTERFACE .....	46

## LIST OF TABLES

TABLE 2.1: COST ANALYSIS.....	18
TABLE 2.2: INDIVIDUAL RESPONSIBILITY .....	14

## **ABSTRACT**

This project focuses on the development and implementation of a smart articulating system for efficient irrigation in agricultural fields. The objective of this work was to design and construct a system that can monitor and control various parameters such as soil moisture, temperature, humidity, and rainfall, and accordingly regulate the irrigation process. The project involved the use of a microcontroller, Arduino Uno, along with sensors including DHT11, rain sensor, and soil moisture sensor. The hardware model was designed and implemented, and a simulation was conducted using Proteus software to validate the system's functionality.

Furthermore, an Android application, Blynk, was used to monitor and control the hardware components remotely. This allowed users to access real-time data and make necessary adjustments to the irrigation process based on the sensor readings. The results obtained from both the simulation and hardware implementation were analyzed and compared. It was found that the system successfully regulated the irrigation process based on the measured parameters, leading to efficient water usage and improved plant growth. The novelty of this work lies in the integration of multiple sensors and the use of a microcontroller to create an automated irrigation system. By leveraging modern technologies, such as mobile applications and IoT, the system offers convenience and flexibility to farmers in managing irrigation remotely. This project demonstrates the successful development and implementation of a smart articulating system for efficient irrigation. The results obtained align with the predicted values and existing publications, showcasing the effectiveness of the proposed solution. The project has achieved its initial targets of creating an automated irrigation system and validating its functionality. The findings of this work contribute to the field of agricultural engineering, highlighting the potential of smart systems in optimizing irrigation processes and promoting sustainable farming practices.

# Chapter 1

## INTRODUCTION

### 1.1.Overture

Agriculture is a crucial industry that has far-reaching effects on humankind. Farmers have been gathering and consuming plants for thousands of years, all the way from the ancient to the agricultural revolution in Great Britain England. There are several cropping system supporting technologies that have helped farmers greatly. Harvest machines, seed drill machines, reaper machines, and many others have reduced the need for human labor and the amount of time spent on agricultural tasks, but they are just a few examples of the many technologies that have had an impact on agriculture since the era of the agricultural revolution. Few studies have been conducted on "smart farming" recently. The proposed system was put to use in order to keep an eye on the potato fields in order to look for illnesses and dangerous fungi, as well as to keep track of data that might be used to better plan future plantings and manage resources like water and soil. A higher harvest is possible with the use of smart agricultural technology. This paper presents a proposal for an intelligent agricultural system. To improve yield and quality, "smart farming" implements Internet of Things (IoT) principles to provide farmers with tools for remote monitoring and on-site sensing. The term "Internet of Things" (IoT) refers to a set of protocols and infrastructure that allow inanimate objects to exchange data and interact with one another. This is useful for shifting practices in commercial and agricultural settings toward greater efficiency. To increase crop yields, a strategy is developed that outlines smart farming. The backbone of smart farming is a network of sensors and a corresponding control system. A sensor system is the collection of measuring instruments used to collect data. A human interface controls the blower, watering, and roofing systems. The sensor and controlling system is coded into two separate Arduino boards. Python is used for the control programming. Two distinct displays, an LCD screen and a serial monitor, show the values sensed by the various sensors. A database of the findings is kept in an Excel sheet, and a graphical representation of the data is also obtained. The python control panel then activates the control system in response to the sensor system's output. The right decision-making procedure leads to a rise in both product quality and quantity.

## **1.2. Engineering Problem Statement**

Design and develop a system that utilizes sensor technology and data analysis to optimize crop yields, reduce resource consumption, and improve overall sustainability in agricultural operations." The system should be able to collect data on factors such as soil moisture, temperature, and nutrient levels, and use that data to make automated decisions about irrigation, fertilization, and other agricultural practices. Additionally, the system should be able to provide farmers with real-time information about the health and productivity of their crops, as well as insights into how to improve their operations

## **1.3. Related Research Works**

Briefly discuss the research works done related to the focused topic. Provide proper referencing [IEEE format] and indicate how the results / outcome of mentioned research works helps to build the project.

### **1.3.1. Earlier Research**

#### **1.3.1.1. An energy-efficient wireless sensor network for precision agriculture**

Information and control technologies, when applied to fields like precision agriculture, need the usage of wireless sensor networks. For a precision agricultural application that necessitates the regular collecting of sensor readings from predetermined places across a field, we develop the MAC and Network layers for a wireless sensor network [4]. The radio used in the Physical layer can send with varying intensities and receive with adjustable sensitivity. The media access control layer (MAC) was developed to reduce power consumption during the initial synchronization phase after awakening. The network layer is tailored to the requirements of the application, in this case, periodic data collecting from fixed sites, while also minimizing energy usage by distributing the communication burden evenly. In order to meet the needs of the application as a whole, designers must employ a cross-layer design strategy while creating the various protocol layers that make up the protocol stack.

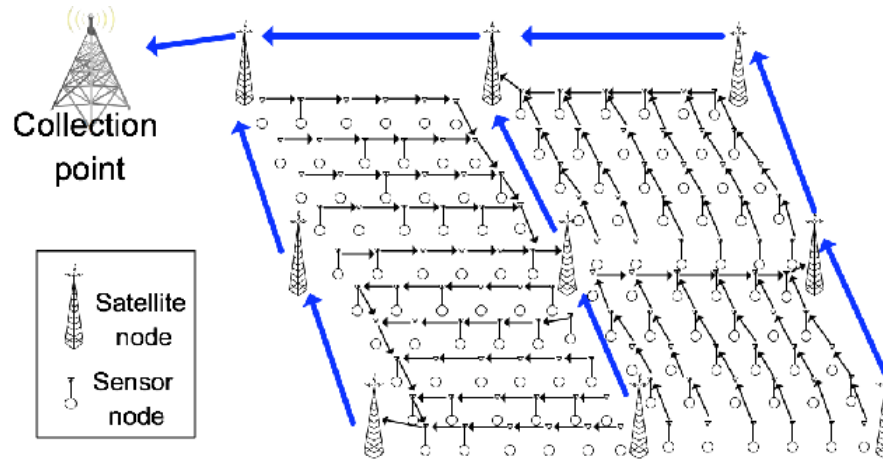

Figure 1.1 Wireless sensor network, showing sensor and satellite station deployment [4].

### 1.3.1.2. An Environment Monitoring System for Precise Agriculture Based on Wireless Sensor Networks

This study designs and executes an environment monitoring system for precise agriculture based on wireless sensor networks in a red bayberry greenhouse on a hillside to address issues including poor real-time data acquisition, limited monitoring coverage area, and a high need for human labor [5]. This system may send real-time data through GPRS to a remote server regarding the environment surrounding the deployment site, including the temperature, humidity, illumination, voltage, and other characteristics. To broadcast the current state of the greenhouse's ecosystem and offer a continuous voice and SMS alert service, this system makes use of a web-based platform that is connected with Google Maps. The device is powered by solar energy and storage batteries due to the absence of a conventional power grid in the trial location. The results of the experiments demonstrate the strong scalability of the low-cost system and its capacity to deliver a steady, accurate, and real-time service for precision agriculture.

relays the acquired data to the gateway node.

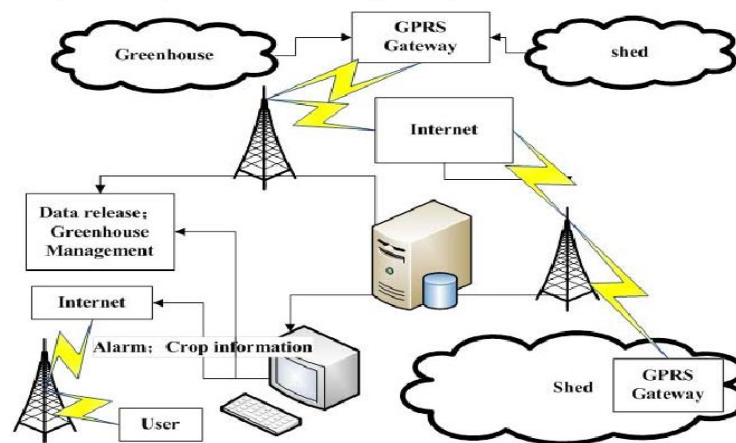

Figure 1. System Infrastructure

Figure 1.2 System Infrastructure [5]

### 1.3.1.3. Research on the agriculture intelligent system based on IOT

The introduction of the agriculture intelligent system based on IOT for organic melon and fruit production is motivated by the necessity to make the shift from traditional to modern agriculture in China, as outlined in the Spirits of 2012 Central No. 1 Document of the People's Republic of China. The system made use of several cutting-edge technologies, including RFID, sensors, and others. There are three different levels to this system [6]. The platform's expert system service built a mathematical model to track the ripening melons' data and reach a conclusion. Environment, water, and fertilizer distribution could all be managed by the smart production management platform. Fruit farmers and buyers alike benefit from the added convenience of an online trading platform that includes a traceability feature. In order to regulate the conditions under which crops flourish, to maximize the efficiency with which fruit is planted, etc., it is significant that the Agriculture Intelligent System was created. Assuming widespread use, the technology will help fruit farmers in the area.

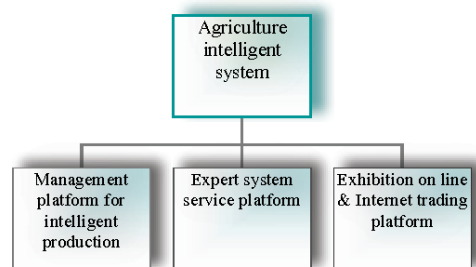

Figure 1. The modules of agricultural intelligent system

Figure 1.3 The modules of agricultural intelligent system [6]

### 1.3.1.4. Successful Deployment of a Wireless Sensor Network for Precision Agriculture in Malawi

Using a wireless sensor network, this paper shows how an irrigation management system (IMS) can be put into practice (WSN). This article details the implementation of an IMS in Blantyre's Manja Township. Grid power is rare in rural areas of impoverished countries like Malawi, making it difficult to deploy IMS. The study used solar photovoltaic and rechargeable batteries to power all electrical devices, making the

system self-sufficient in terms of power. Soil temperature, soil moisture, WSN link performance, and photovoltaic power levels were all reported remotely using a General Packet Radio Service modem built into the system [7]. The land was watered by turning on the irrigation valves. The study's first findings highlight a number of engineering challenges associated with installing such a system. However, the article has shown where more work has to be done to create an IMS that is suitable for the economic and social circumstances of small-scale farmers in poor nations and is also resilient, completely automated, solar-powered, and inexpensive.

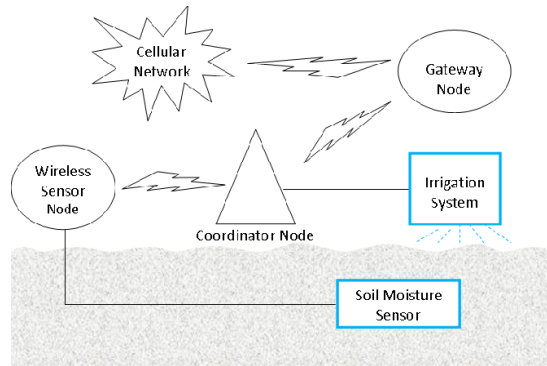

Figure 1.4 System architecture [7]

### 1.3.2. Recent Research

Any related researches which are generally not more than 5 years or 2 years old can be considered recent work. A clear indication should be there how the recent research complements the proposed project methodology.

#### 1.3.2.1. IOT Based Automated Indoor Hydroponic Farming

Slowly but surely, hydroponics is transforming the agricultural sector. The capability of indoor cultivation adds a new dimension to farming. In this work, we create a completely automated small fodder grow chamber that can produce fodder in less than a week when used inside. It uses a climate-controlled chamber to keep a steady flow of cold air through the space, grow lights to replicate sunlight, and a water and moisture monitoring system to guarantee ideal indoor growing conditions [8]. The system uses an Arduino controller connected to a keypad to gather information about water replacement and flow rates, as well as the ideal temperature within the building. The system then uses water sensors, moisture sensors, and temperature sensors to constantly keep a tab on indoor conditions. The motor of the pump is used to regulate the water level, while sensors for moisture and temperature keep the environment at an optimal level for plant growth at all times. The user can program the artificial lighting in their home to turn on and



off at specific times. An arduino controller expertly oversees the entire activity to guarantee its reliable, consistent repetition. If the water tank ever becomes low, the system will alert you. Because of this, the system guarantees an automatic indoor fodder grow system managed by an arduino controller.

### **1.3.2.2. Improving the performance of agriculture irrigation system using Arduino**

When rain falls insufficiently, farmers use irrigation to keep their crops growing. And it's also utilized for landscaping purposes. Providing the necessary quantity of water with the precious time feed to the crops is the most challenging challenge today, and as a result, farmers are having a hard time achieving desirable crop yields. A fully automated watering system would be the best solution to this issue. Recent years have seen a surge in the number of studies devoted to autonomous irrigation as a means of easing farmers' workloads and ensuring that crops are being cultivated at the optimal times. In the work proposed here, an Arduino Uno is used to automate the irrigation operation. Along with the Arduino, a functional irrigation system is provided by various accessories and components including a moisture sensor, solenoid valve, relay modules, and an adapter [9]. The goal of the suggested system is to automatically supply the crops with the water they need based on their individual characteristics, as determined by the arduino code. Another benefit is that it keeps farmers safe from the potentially dangerous insects that inhabit agricultural fields at night.

### **1.3.2.3. Smart agriculture using IoT**

Using the Internet of Things (IoT), "smart agriculture" provides a better solution for water conservation, lowers labor costs, conserves electricity, and allows the farmer to keep a wireless record of his harvests all year long. This study focuses on an IoT-based application for sustainable farming practices, which involves monitoring soil moisture with a soil moisture sensor module, sending data about that moisture to a server using an ESP-8266 Wi-Fi module, and then using an Arduino Uno R3 to switch on and off a submersible motor pump (motor driver-289D) [9]. The computer initiates a communication request on the specified THINKSPEAK APP server webpage, which then graphically presents the current sensor values and pump status. The prototype was developed and tested to collect soil moisture data in real time, transmit that data to an Arduino via serial communication via an ESP-8266 Wi-Fi module, and then plot that data on a custom THINGSPEAK channel. The data can be viewed remotely via a mobile app called virtuino, which also aids in the control of the water pump.

### 1.3.2.4. Using IoT Innovation and Efficiency in Agriculture Monitoring System

There's no denying that agriculture is a major source of income in China. Growing populations necessitate better ways to maximize crop yields. The need for freshwater utilized for irrigation rises along with the capture of support and the expansion in agricultural output. 80 percent of China's current water use is used for agriculture. Waste occurs when there is an unexpected excess of water and no precautions are taken to prevent it. Thus, we decided to use Arduino to build a programmed plant irrigation system that automatically waters plants and keeps the user informed via message transfer. The soil moisture sensor is a tool used in an automated watering system for plants. Arduino triggers a water pump to re-hydrate the system if the relative humidity drops below a certain threshold. When the organism senses that there is enough water in the ground, the pump is supposed to turn off automatically [10]. A message is sent to the user's IoT device each time the system is turned on or off, including the soil's moisture level and the status of the water pump. The idea of a crane serves as the foundation for a water pump and spray motor. This method works well for small plots of land such as gardens, farms, etc. This layout required zero manual labor on the part of the designers. In addition, the sensor data is transmitted via a Thing talk frequency, which generates visual elements that may be used to further investigate the data. This research brings together the concepts of the Internet of Things (IoT) with some engineering tools such as machinery, artificial intelligence, and the use of sensors in an effective manner to respond to current needs and extract resources by making use of scientific methods and procedures that rely on inputs. In addition, the engineering works that have been a part of this sector are further defined in this study, but greater efficiency, reduced energy consumption, and lower prices will be achieved through increased IoT contributions in agricultural engineering.

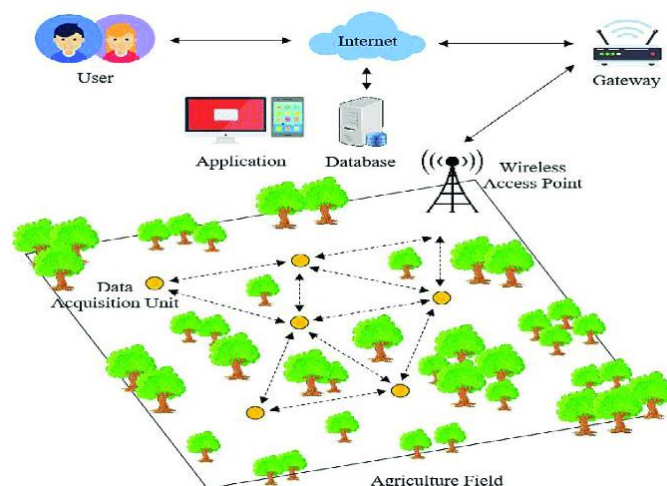

Figure 1.6: Wireless sensor network layout for automated irrigation system [10]

### 1.3.2.5. Mulched dripping irrigation system concept driven by arduino for tomato and green tomato crops in urban gardens

This paper describes an Arduino-controlled mulched dripping irrigation system for small-scale urban gardens, specifically built for tomato and green tomato crops. Dripping irrigation is powered by Arduino boards, and the system's operation rests on the collection of data about soil moisture, temperature, and humidity from sensors. To demonstrate the benefits of both horizontal and vertical farming, we employed tomato and green tomato crops as a case study. The necessities of precision agriculture, the effects of climate change, and the actual EU Directives for conservation of natural resources all make the novel idea essential.

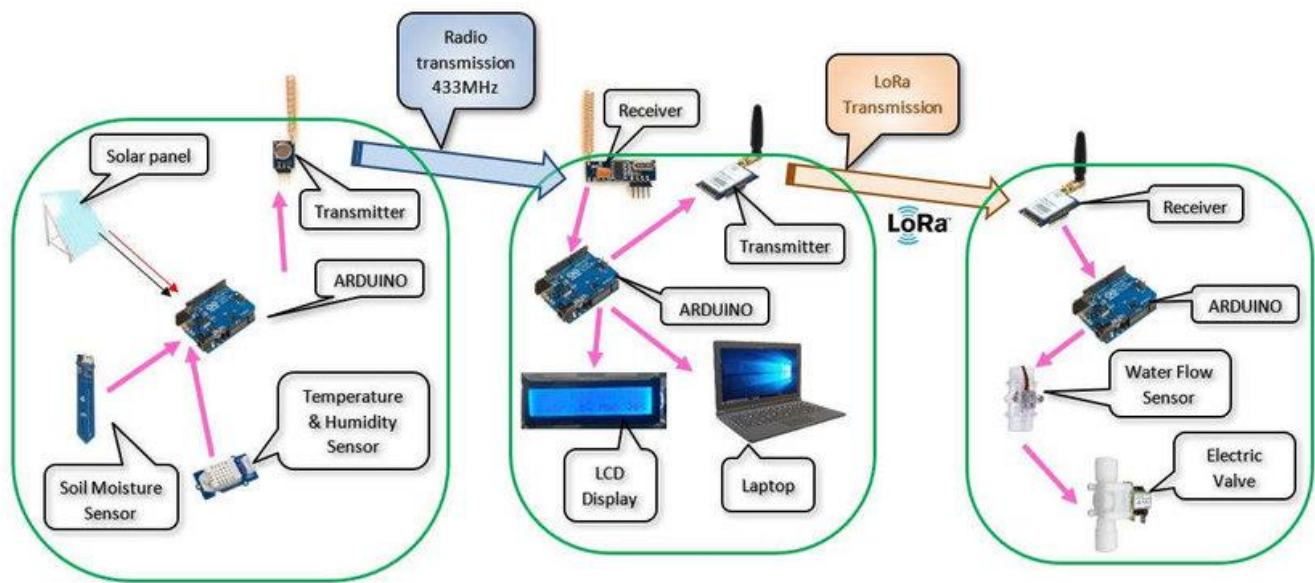

Figure 1.7: The functional scheme of the SMART Irrigation System and the information flow Left -Sensor Board (data regarding soil moisture, temperature and humidity), Middle -Core Board (data interpretation, correlation and command) and Right -Drive Board (water release and flow measurement) [11]

### 1.3.2.6. Design of a Wireless Underground Sensor Network for Precision Agriculture

Recently, Wireless Underground Sensor Networks (WUSNs) have gained popularity due to the great variety of uses they can serve. Mine detection, landslide research, ecological observation, and targeted

agricultural practices are all examples of such uses. It is the responsibility of the nodes buried below the surface to ensure optimal plant growth by checking the soil's moisture, temperature, and nutrient levels. As a result, the user can select whether or not to water or fertilize a specific region, leading to more effective use of those resources. Electromagnetic (EM) waves used in wireless communications are greatly attenuated due to soil qualities that may change over time, as the ground itself is the communication channel (it is thicker than the air). As a result, due to signal loss in soil, a sensor node must expend energy relaying the data it has sensed to a destination node that may never receive it. A WUSN needs to have in place beforehand so that buried sensor nodes can communicate reliably with one another. The purpose of this thesis is to pave the way for secure, low-power communication in WUSNs, which will facilitate the use of precision agriculture in real time. To this end, we devised a model for predicting signal loss in precision agriculture using wireless underground sensor networks termed WUSN-PLM. Extensive measurements were taken in a real agricultural field of onions culture at the Botanic Garden of the University of Cheikh Anta Diop in Dakar to verify the accuracy of the proposed WUSN-PLM. On average across all 140 metrics, WUSN-PLM is 87 percentage points more accurate than the best existing models. In addition, we suggested a link channel optimization for dependable communications in WUSNs based on the Sugeno Fuzzy Inference System, which allows for real-time prediction of the packet loss (FIS). A total of four inputs, one output, and thirty-six rules make up the proposed FIS. Information about the soil moisture proportion, the average distance between nodes, and the depth to which the transmitter and receiver nodes are buried are provided as inputs [12]. A packet's likelihood of being received at the destination node is calculated by the FIS and displayed as an output based on the input parameters. By comparison to WUSN-PLM, the suggested method achieves higher accuracy and precision in the evaluation (91429 and 87129, respectively). The ARDUINO-based sensor nodes that employ the Fuzzy Logic-based method have been put to use in the real world.

## **1.4.Critical Engineering Specialist Knowledge**

Using technology, collaborating, communicating, providing real-time data from sensors wirelessly for processing, and providing more important information for effective decision making are all aspects of what we mean when we talk about the Internet of Things (IoT). The Internet of Things (IoT) is a rapidly evolving technology with limitless potential for improving human lives in domains as diverse as medicine, military, industry, agriculture, and more. To put IoT into action, one must be familiar with the research field, including its physical equipment and the possibility of connecting those items to the internet. IoT is more like physical things connected to the internet, communicate, and share data to each

other, which are smart devices. IoT is not a new idea, but recent advancements in hardware technology have made it popular for implementation. The Internet of Things (IoT) with sensor networks introduces a novel instrument for interacting with and observing data from the physical world in real time via automation and decision making. With the use of IoT, farmers might keep tabs on their crops and the conditions in which they thrive. Data mining and analysis is seen as a necessary duty, just as collecting the raw data is. Several problems plaguing agriculture field products can be addressed with the use of the Internet of Things (IoT), allowing us to better foresee, track, and control the life cycle of agricultural goods. Despite India's massive population and reliance on agriculture as a primary source of income, only around half of the country's inhabitants currently make a living in this way. Our proposed architecture model has three distinct layers: the "physical layer," the "Internet of Things" layer, and the "com-op" layer. Together, they serve as the management system for the integrated monitoring and automation services for end users. The system can handle every agricultural problem, from animal management to quality control to supply chain coordination, and so on.

## **1.5.Stakeholders**

To effectively engage in the agricultural supply chain, it is helpful to have a working knowledge of the many different types of external stakeholders involved, including seed and fertilizer producers, agricultural retailers, farmers and ranchers, agricultural credit institutions, crop consultants and advisors, aggregators, processors, distributors, transportation and refrigeration companies, and ingredient manufacturers. One rising issue of critical importance for both farmers and packers and distributors in the agriculture business are the management and engagement of stakeholders across the whole supply chain. A growing number of people in the agricultural supply chain have voiced a need for farm management systems that can effectively execute a stakeholder management protocol. Implementing tech-driven stakeholder management tools in different farm management systems is predicted to emerge as a popular trend in the agricultural business as it moves swiftly towards smart technological integration across much of its value chain. Supply chain management is becoming increasingly difficult for the agriculture industry as a whole due to a number of factors, including climate change, stringent food quality regulations, and the growing urgency to make farming more sustainable. Most parties involved are turning to high-tech solutions, such farm management software, to address these issues. However, the management of stakeholders is an extra difficulty for the agriculture sector.

## **1.6.Objectives**

### **1.6.1. Primary Objectives**

- When farming is connected to the Internet of Things, farmers can track their yields and environmental conditions in real time.
- They have the ability to quickly gain insights, foresee potential problems, and make well-informed decisions on how to prevent them.
- The usage of water, energy, and land can all be improved with the help of numerous IoT solutions.

### **1.6.2. Secondary Objectives**

- Reduced pesticide and fertilizer use is a real benefit of "smart farming," which makes use of the Internet of Things.
- Increased process agility is a positive side effect of implementing IoT in agriculture.
- Using data to guide agricultural practices results in increased yields and improved quality.

## **1.7. Organization of Book Chapters**

### **Chapter 2: Project Management**

The project management chapter focuses on the systematic planning and execution of the project. It begins with the development of a Gantt chart, which outlines the timeline and tasks involved in the project. Additionally, this chapter analyzes various aspects related to the project, including strengths, weaknesses, and opportunities for improvement.

### **Chapter 3: Methodology and Modeling**

The methodology and modeling chapter delves into the approach and techniques employed in the project. It starts by presenting the proposed design, which is illustrated through a block diagram. Furthermore, this chapter provides a mathematical analysis of the proposed model, showcasing the underlying principles and calculations involved.

### **Chapter 4: Implementation of Project**

The implementation chapter explores the practical aspects of the project. It offers a detailed description of how the proposed model was realized and executed. This includes the hardware and

software components used, along with any modifications made to the original design. The chapter provides insights into the technical implementation process and highlights the key features of the final project model.

### **Chapter 5: Results Analysis & Critical Design Review**

In this chapter, the focus is on analyzing and evaluating the results obtained from the project. Various graphs, charts, and statistical data are presented to provide a comprehensive analysis of the project outcomes. Additionally, a critical design review is conducted, assessing the strengths and weaknesses of the implemented model and identifying areas for potential improvement.

### **Chapter 6: Conclusion**

The final chapter serves as a conclusion to the entire book. It summarizes the key findings, achievements, and contributions of the project. It also reflects on the challenges faced during the project and provides recommendations for future work. The chapter wraps up the book by offering a comprehensive overview of the project and its implications.

## Chapter 2

# PROJECT MANAGEMENT

### 2.1.Introduction

The project of an IoT-based smart articulating system was planned and managed using appropriate engineering management principles. The team followed a systematic approach that involved different stages to ensure the success of the project.

Firstly, the team conducted a thorough analysis of the requirements of the system. This involved identifying the desired functionality, performance, and reliability of the system, as well as any regulatory requirements. Based on the requirements analysis, the team defined the scope of the project, including the key features and components of the system, and identified any constraints such as budget, timeline, and resources. To manage the risks associated with the project, the team conducted a risk assessment and developed a risk management plan. This involved identifying potential risks and developing strategies to mitigate or minimize those risks. The team also developed a project schedule that outlined the key milestones and deadlines for the project. This schedule was regularly reviewed and updated to ensure the project was on track and any delays or issues were addressed promptly. Resource management was also a critical aspect of the project. The team identified the necessary resources for the project, including personnel, equipment, and materials, and allocated these resources efficiently to ensure they were used effectively throughout the project.

### 2.2.S.W.O.T. Analysis

SWOT analysis is a strategic planning tool that stands for Strengths, Weaknesses, Opportunities, and Threats. It is commonly used to evaluate an organization's or project's position in its market or industry. Here is a SWOT analysis of the IoT-based smart articulating system project:



### **2.2.1. Strengths:**

- The project is based on IoT technology, which is a rapidly growing and innovative field.
- The system will provide users with improved functionality, including the ability to articulate and control objects remotely.
- The system could potentially save users money by automating tasks that would otherwise require manual labor.
- The use of IoT technology in the project could give the organization a competitive advantage in the market.

### **2.2.2. Weaknesses:**

- The project may face technical challenges, such as compatibility issues with existing technology and the need for extensive testing and validation.
- The system may have a limited user base, as it is designed for specific use cases.
- The project may be expensive to develop and implement, which could limit its feasibility for some users.

### **2.2.3. Opportunities:**

- The IoT market is expected to continue to grow rapidly, creating opportunities for the system to be adopted by new users.
- The organization could form partnerships with other companies to develop and market the system, expanding its reach.
- The system could be customized to meet the specific needs of different user groups, expanding its potential market.

### **2.2.4. Threats:**

- Other companies may develop similar systems, posing a threat to the system's market share.
- IoT technology is often associated with security risks, such as hacking and data breaches, which could harm the system's reputation.
- Changes in regulations or standards could impact the system's development and implementation.

## **2.3. Schedule Management**

Gantt charts were used to visualize the project schedule and track progress against milestones. This tool allowed the team to identify any delays or issues and make adjustments to the schedule as necessary.

## 2.4. Cost Analysis

Equipment	Cost
ESP32	650
4 Channel Relay	400
DHT11	150
Switch Panel	400
Cooling Fan	400
Humidifier	500
Rain & Moisture Sensor	200
Buzzer & Wire -	200
Pump	600
Air Quality Sensor	500
PCB, Switch & VR	800
Gear Motor	600
Motor Driver	300
3D Printed Parts	2000
Interior	2000
Miscellaneous	1000
Total=	10,700

## 2.5.P.E.S.T. Analysis

A PEST analysis is a tool used to analyze the external factors that may impact a project or organization. It stands for Political, Economic, Social, and Technological factors. Here is a PEST analysis for the IoT-based smart articulating system project:

### 2.5.1. Political:

Changes in regulations related to IoT technology, data privacy, and cybersecurity could impact the development and implementation of the system. Government policies: Government policies related to technology innovation and funding could impact the project.

### **2.5.2. Economic:**

The economic conditions in the market where the system will be sold could impact its adoption and success. The cost of developing and implementing the system could impact its feasibility for some users.

### **2.5.3. Social:**

The social acceptance of the technology and willingness of users to adopt it could impact the success of the system. The demographics of the user base, such as age and geographic location, could impact the demand for the system.

### **2.5.4. Technological:**

The development of new technologies could impact the competitiveness of the system and its relevance in the market. Compatibility issues with existing technologies could impact the development and implementation of the system.

By conducting a PEST analysis, the project team can identify external factors that may impact the project and develop strategies to mitigate any potential risks. This analysis also supports engineering management principles by helping the team make informed economic decisions based on the external factors affecting the project.

## **2.6. Professional Responsibilities**

Ensuring compliance with applicable laws and regulations related to the development, testing, and implementation of the system. Ensuring the system is designed and developed with consideration for user safety, reliability, and efficiency. Conducting thorough testing and validation of the system to ensure it meets the required specifications and quality standards. Collaborating effectively with team members from different disciplines to ensure the system is developed and implemented successfully. Continuously learning and keeping up to date with advances in technology and engineering practices relevant to the project. Communicating clearly and effectively with stakeholders, including team members, customers,

and regulators, to ensure the project is well understood and all concerns are addressed. As a team member, engineers have a responsibility to contribute their expertise and work collaboratively with other team members to achieve project goals. They must also prioritize open communication and timely feedback to ensure the project is progressing as planned. By upholding these professional responsibilities, engineers can help ensure the success of the IoT-based smart articulating system project and promote the integrity of the engineering profession.

### **2.6.1. Norms of Engineering Practice**

Engineering practice involves the application of scientific and mathematical principles to design, develop, test, and maintain various products, systems, and processes that meet the needs of society. The general engineering practice involves identifying the problem, defining the requirements, designing the solution, testing and validating the solution, and implementing the solution.

**Safety:** The team designed the system with safety as a top priority. They identified potential safety hazards and implemented measures to prevent or mitigate any risks to users.

**Reliability:** The team designed the system to be reliable and meet the required specifications. They conducted thorough testing and validation to ensure the system was reliable and met quality standards.

**Efficiency:** The team designed the system to be efficient to optimize its performance and minimize its impact on the environment. They considered factors such as energy consumption and environmental impact in the design process.

**Collaboration:** The project team worked collaboratively to ensure the system was developed and implemented successfully. They communicated effectively with team members from different disciplines to ensure the project was well understood, and all concerns were addressed.

By following these engineering guidelines, the project team ensured that the IoT-based smart articulating system was developed and implemented in a safe, reliable, and efficient manner, meeting the required specifications and quality standards. This helped to promote the integrity of the engineering profession and ensure the successful outcome of the project.

### **2.6.2. Individual Responsibilities and Function as Effective Team Member**

In a team-based project like the IoT-based smart articulating system, each team member had individual responsibilities and accountabilities to ensure the project's successful completion. The project manager was responsible for overall project planning, execution, and control, while the system architect was responsible for designing the system architecture, defining the system requirements, and developing the system specifications. The software developer was responsible for developing the software components of the system, and the hardware developer was responsible for developing the hardware components. The test engineer was responsible for testing and validating the system components.

## **2.7. Management Principles and Economic Models**

In the IoT-based smart articulating system project, several engineering management models and principles were followed to ensure its successful completion. One example of this is the Agile project management methodology, which was used to manage the project's development process. Agile allowed the team to respond to changes quickly, which is essential in a project that involves complex and evolving technology. The team also followed the Systems Engineering approach to manage the system's requirements, design, and implementation.

Additionally, the team followed the Lean manufacturing principles to optimize the project's efficiency and reduce waste. For example, the team minimized unnecessary features and focused on developing only the essential system features, which helped to reduce costs and development time.

In terms of economic models, the team used cost-benefit analysis to determine the feasibility and economic viability of the project. The team also considered the return on investment (ROI) and the payback period to assess the project's profitability. By conducting a thorough economic analysis, the team was able to ensure that the project was economically feasible and would provide value to its stakeholders.

## **2.8. Summary**

The IoT-based smart articulating system project was managed systematically and effectively, resulting in its successful completion. The project was planned and managed using appropriate engineering management principles, including Agile project management, Systems Engineering, Lean manufacturing principles, cost-benefit analysis, ROI analysis, payback period analysis, and value engineering. The project team followed a systematic approach to manage the project, beginning with the identification of the system requirements, followed by the design and implementation of the system, and finally, the testing

and validation of the system. The team also utilized several tools and techniques, including Gantt charts, critical path analysis, risk management, and cost tracking to ensure that the project was completed within the given schedule and budget.

Furthermore, the project team worked collaboratively as an effective team, with each member contributing their skills and expertise to the project. The team members had individual responsibilities and accountabilities and functioned effectively as a multi-disciplinary team, ensuring that the project was completed successfully.

## Chapter 3

# METHODOLOGY AND MODELING

### 3.1.Introduction

The IoT-based smart articulating system project utilized several engineering theories and methods to design, develop, and implement the system successfully. Some of the basic engineering theories used in the project included Control Theory, Signal Processing, Electronics, and Mechanics. These theories were applied to develop a system that could communicate wirelessly, process signals from various sensors, and operate mechanical components effectively.

Moreover, the project team utilized several engineering methods to ensure that the system met the specified requirements. Systems Engineering was used to define the system requirements, identify the subsystems, and integrate the subsystems into a working system. Additionally, Lean manufacturing principles were used to eliminate waste, increase efficiency, and reduce costs during the design and manufacturing process. Value Engineering was also used to optimize the system design, ensuring that the system provided the required functionality at the lowest cost possible.

Furthermore, the project team employed several testing and validation methods, including Functional testing, Environmental testing, and Performance testing, to ensure that the system met the desired specifications. The team also utilized statistical analysis to identify and resolve any issues that arose during the testing and validation process.

### 3.2. Block Diagram and Working Principle

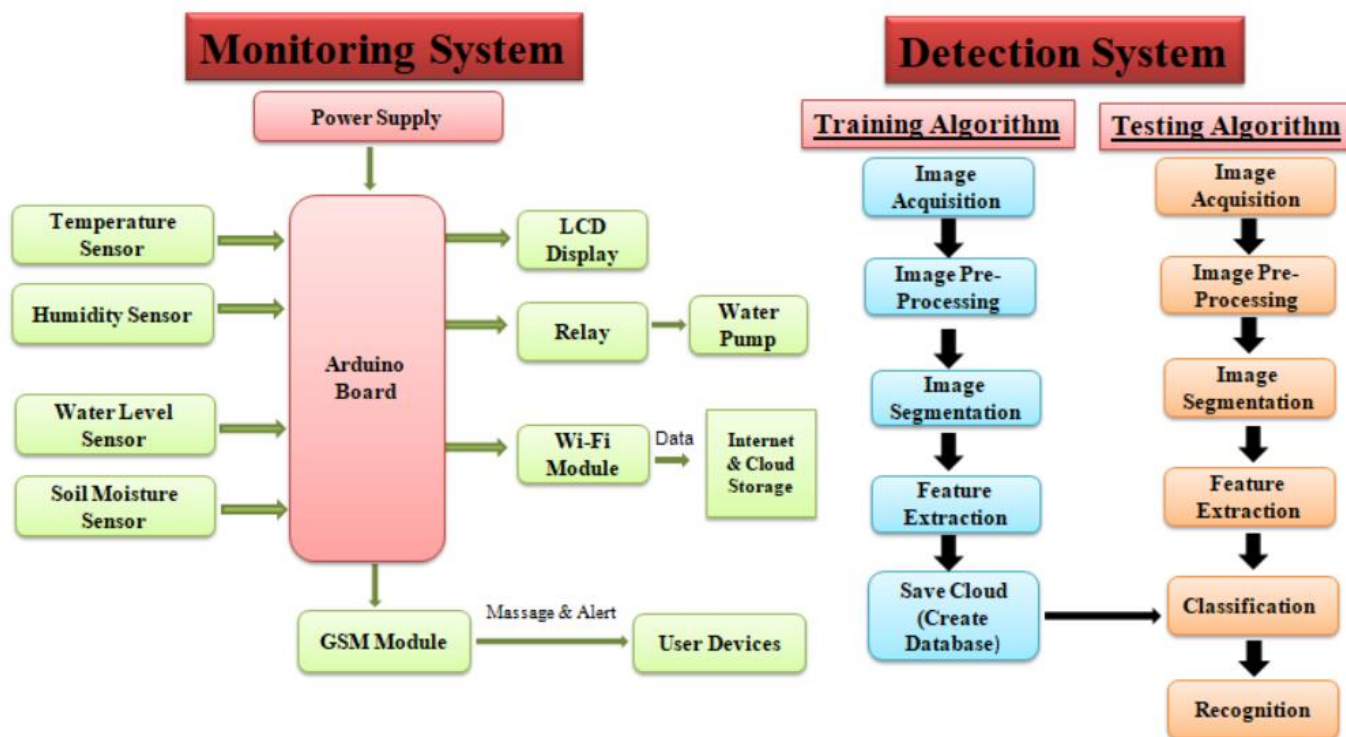

**Figure 4.1:** Block diagram of the Project

In the monitoring system diagram, the various sensors (temperature, humidity, soil moisture, and water level) are connected to the Arduino Uno microcontroller, which acts as the central control unit. The data from the sensors is processed by the Arduino and used to make decisions about the operation of the system. The temperature sensor is used to measure the temperature of the environment. This information is important for understanding the conditions that plants and crops are growing in and making decisions about watering and other factors that affect their health.

The humidity sensor is used to measure the relative humidity of the environment. This information is important for understanding the moisture levels in the air and making decisions about watering and other factors that affect the health of plants and crops. The water level sensor is used to measure the level of water in a storage tank or other water source. This information is important for ensuring that there is enough water available for irrigation and for preventing over-watering or water waste. The soil moisture sensor is used to measure the moisture level of the soil. This information is important for making decisions about watering and other factors that affect the health of plants and crops. The relay acts as an intermediary between the microcontroller (Arduino Uno) and the water pump. The



microcontroller sends a signal to the relay, which in turn activates the water pump. This allows the microcontroller to control the operation of the water pump, and to make decisions about when to turn it on or off based on the information gathered by the sensors.

For example, if the soil moisture sensor indicates that the soil is too dry, the microcontroller can use the relay to activate the water pump and irrigate the plants. Similarly, if the water level sensor indicates that the water level is too low, the microcontroller can send an alert or message to the user, and take appropriate action, such as turning off the water pump. By using a relay to control the water pump, the microcontroller can ensure that the pump is operated only when needed, and can prevent over-watering or water waste, which can conserve resources and reduce costs.

The data gathered by these sensors is processed by the Arduino Uno microcontroller and used to make decisions about the operation of the system, such as activating the water pump, sending alerts and messages, and updating the LCD display. The information is also transferred to cloud storage via the Wi-Fi module, where it can be analyzed and accessed remotely. The GSM module is used to send messages and alerts to a remote device, while the LCD display is used to display the results of the system locally. The relay is used to control the water pump, which can be activated based on the readings from the sensors.

Finally, the Wi-Fi module is used to transfer the data from the system to cloud storage, where it can be accessed and analyzed remotely. The data gathered by the sensors and other components of the system can be sent to the cloud storage via the Wi-Fi module, where it can be stored and analyzed. This allows the data to be accessed from anywhere with an internet connection, and can provide a centralized repository for all of the data gathered by the system. The Wi-Fi module can also be used to receive data from the internet, such as updates or changes to the system configuration, or commands from a remote user. This allows the system to be controlled and monitored from a distance, and can provide greater flexibility and convenience to the user. By using a Wi-Fi module, the monitoring system can communicate with other devices and services on the internet, and can provide a more comprehensive and integrated solution for smart agriculture.

**Detection System:** In this diagram, the training algorithm takes images as input and performs various steps to extract features and create a database of images and their corresponding features. The steps include image acquisition, image pre-processing, image segmentation, and feature extraction. The

resulting features are then classified and saved to cloud storage, which acts as a database for recognition.

The testing algorithm also takes images as input and performs similar steps to the training algorithm, but does not create a database. Instead, the extracted features are compared to the database created during the training phase to determine the recognition of the object in the image. Both algorithms are connected to the recognition component, which makes the final decision about the object in the image.

### 3.3.Modeling

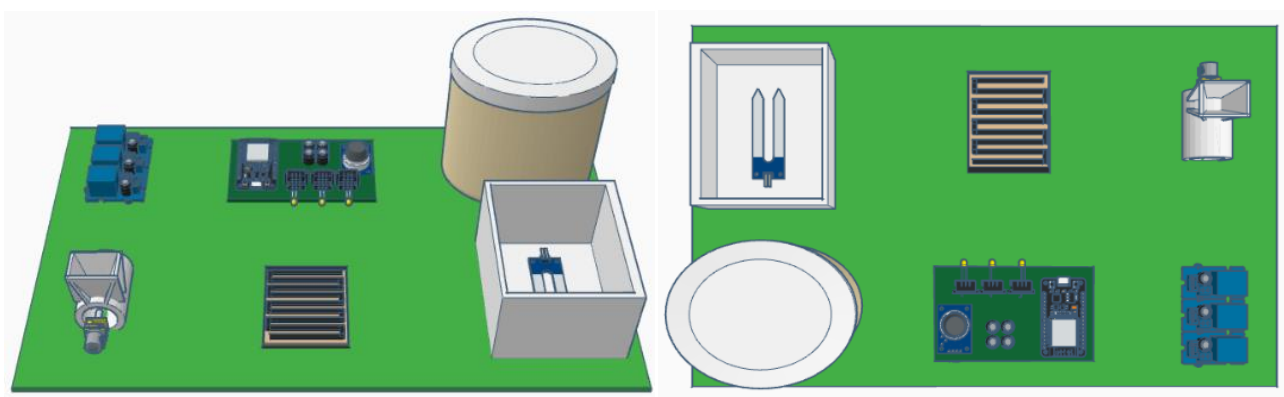

**Figure 3.2:** 3D model of the project

The 3D model for this project was created using Autodesk Fusion 360, a powerful computer-aided design (CAD) software. Fusion 360 allowed us to design and visualize the components and structure of the project in a three-dimensional space.

Using Fusion 360, we meticulously designed the various components of the project, including the enclosure, mounting brackets, and other mechanical parts. We took into consideration the dimensions, tolerances, and functionality of each component to ensure a precise and functional design.

The software provided a comprehensive set of tools and features that facilitated the creation of complex geometries, assembly of multiple parts, and the application of realistic materials and textures. We were able to accurately represent the physical properties of each component and visualize how they fit together in the final product.

Throughout the design process, Fusion 360 allowed us to make adjustments, iterate on the design, and evaluate the overall aesthetics and functionality of the 3D model. We could simulate the movement and interaction of different parts, ensuring that they worked seamlessly together.

The use of Fusion 360 in the design of the 3D model not only helped us visualize the final product but also aided in the identification of any potential issues or conflicts in the design. It allowed us to optimize the design for manufacturability, considering factors such as material selection, ease of assembly, and structural integrity.

Fusion 360 provided us with a powerful platform to create a detailed and accurate 3D model of the project. It helped us visualize and refine our design, ensuring that the final product would meet our requirements and objectives.

### **3.4. Summary**

In summary, the modeling process for this project involved several steps to create the final model. Initially, we conducted research and gathered relevant information about the project requirements and objectives. We then proceeded to identify and select appropriate modeling techniques and tools.

Throughout the modeling process, we iterated on the design, making adjustments and improvements based on feedback and evaluation. We also validated the model through simulations, checking for any issues or conflicts and optimizing the design for manufacturability and performance.

The final model represents a comprehensive and accurate representation of the project. It encompasses all the necessary components, their interactions, and the overall structure. The model aligns with the project requirements and objectives, providing a solid foundation for further analysis, testing, and implementation.

## Chapter 4

# PROJECT IMPLEMENTATION

### 4.1. Introduction

To begin with, the Control Theory was applied to design the system's control algorithm. The control algorithm was designed to ensure that the system operated in a stable and predictable manner, and it was optimized to provide the desired system response for various operating conditions. The algorithm was then programmed into the microcontroller that controlled the system's operations. Signal Processing was utilized to process the signals from various sensors that were used to measure the system's parameters, such as temperature, pressure, and position. The signal processing techniques were used to filter, amplify, and digitize the signals, ensuring that the signals were accurate and reliable. Electronics was used to design the system's hardware, including the microcontroller, sensors, actuators, and communication modules. The hardware was designed to be compact, efficient, and reliable, and it was optimized to reduce power consumption and cost. Mechanics was applied to design the system's mechanical components, including the joints, linkages, and support structure. The mechanical components were designed to ensure that the system had the required range of motion, strength, and stability. Systems Engineering was utilized to ensure that the various subsystems of the system were integrated effectively. The system was designed to meet the specified requirements, and the subsystems were designed to work together seamlessly. Lean manufacturing principles and Value Engineering were applied to optimize the system design and manufacturing process, reducing waste, improving efficiency, and reducing costs.

### 4.2. Required Tools and Components

To successfully implement the project, the following tools and components are required:

#### 4.2.1. ESP32



**Figure 4.1:** ESP32

The ESP32 microcontroller was used in this project as a main component to control and monitor various sensors and devices. Its versatility and compatibility with various hardware components and communication protocols made it an ideal choice for the project. The ESP32 was programmed to collect and process data from the sensors, communicate with the cloud platform, and control the devices based on the analysis of the data. It also provided Wi-Fi and Bluetooth connectivity, which allowed for remote monitoring and control of the system. The use of ESP32 enabled the development of a cost-effective and efficient solution for the project.

#### **4.2.2. 4 Channel Relay**

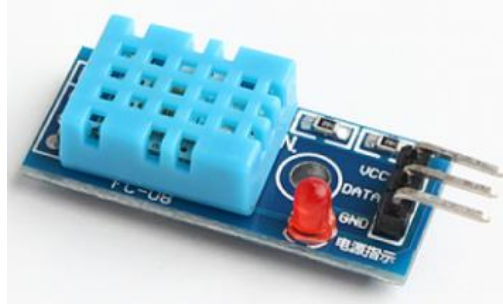

**Figure 4.2:** 4 Channel Relay

A 4 channel relay is an electrical switch that can be controlled by a low voltage signal, typically from a microcontroller or other digital circuit. It is called a "4 channel" relay because it has four separate switches, each of which can be controlled independently. The relay consists of an electromechanical switch and a coil. When a voltage is applied to the coil, it creates a magnetic field that pulls a metal armature towards it, closing the switch. When the voltage is removed from the coil, a spring pulls the armature back, opening the switch. The switch can be used to turn on or off a high voltage electrical load, such as a motor or a light.

In the context of a project, a 4 channel relay might be used to control multiple electrical devices from a single microcontroller or digital circuit. For example, it could be used to turn on and off multiple lights in a room or to control the motors of a robot.

### 4.2.3. DHT11



**Figure 4.3:** DHT11

The DHT11 is a low-cost digital temperature and humidity sensor. It uses a thermistor to measure temperature and a capacitive humidity sensor to measure relative humidity. The sensor provides a digital signal output that can be read by a microcontroller or other digital device. The DHT11 is commonly used in applications where temperature and humidity data are needed, such as in weather monitoring systems, HVAC systems, and indoor environmental monitoring. The sensor is relatively easy to use and is widely available, making it a popular choice for hobbyist and DIY projects.

### 4.2.4. Cooling Fan



**Figure 4.4:** Cooling Fan

A cooling fan is an electronic device that is used to cool down the temperature of electronic components, such as the microcontroller, in a circuit or system. The cooling fan works by blowing cool air onto the heated electronic components, which helps to reduce the temperature and prevent damage to the components due to overheating. In this project, a cooling fan may be used to cool down the temperature of the relay, which can heat up during prolonged use.

#### Humidifier Sensor

A humidifier sensor is a device that is used to measure and control the humidity levels in an environment. It typically consists of a sensor that is sensitive to changes in moisture levels and a control circuit that adjusts the output of the humidifier based on the readings from the sensor. In the context of a smart home automation system, a humidifier sensor can be integrated with other sensors and devices to provide a more comprehensive and automated approach to managing indoor air quality.

#### 4.2.5. Rain & Moisture Sensor



**Figure 4.4:** Rain & Moisture Sensor

A rain and moisture sensor is a device used to detect the presence of rain or moisture in the surrounding environment. It typically consists of a probe that is inserted into the soil or placed on a surface, and it measures the electrical conductivity of the surrounding medium to determine whether there is moisture present. This information can be used to control irrigation systems, prevent overwatering, and conserve water resources. The sensor may also include additional features such as temperature and humidity monitoring, wireless connectivity, and data logging capabilities.

#### 4.2.6. Air Quality Sensor

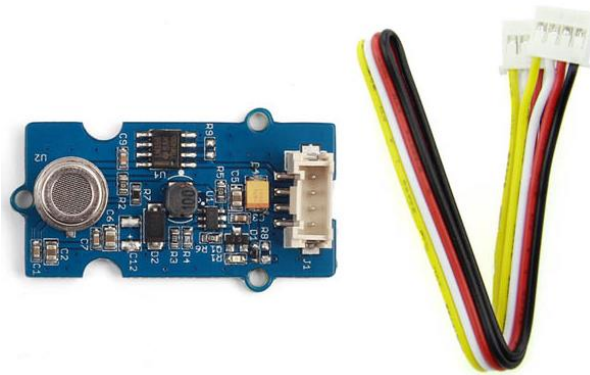

**Figure 4.5:** Air Quality Sensor

An air quality sensor is a device that measures the concentration of certain air pollutants in the surrounding environment. These pollutants can include particulate matter, volatile organic compounds (VOCs), carbon monoxide (CO), and other gases. The air quality sensor used in this project likely measures one or more of these pollutants and provides data to the microcontroller, which can then be used to adjust the ventilation or air purification systems as needed to maintain optimal air quality.

#### **4.2.7. Gear Motor**

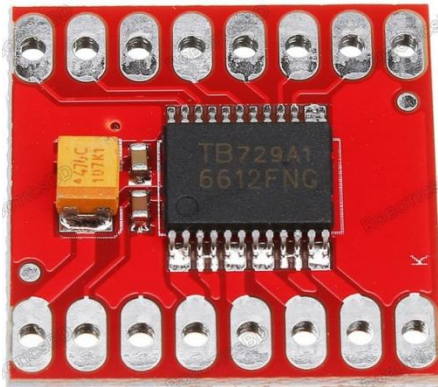

**Figure 4.5:** Gear Motor

A gear motor is a type of electric motor that includes a gear reduction system that provides a mechanical advantage to the motor output. It typically consists of a motor, a set of gears, and an output shaft. The motor drives the gears, which in turn rotate the output shaft. Gear motors are commonly used in applications that require a high torque output and low speed, such as in robotic arms, conveyor belts, and industrial machinery. They are available in a variety of sizes, torque ratings, and gear ratios to meet specific application requirements.



#### 4.2.8. Motor Driver



**Figure 4.6:** Motor Driver

A motor driver is an electronic circuit or device that controls the movement and direction of a motor. It works by receiving commands from a microcontroller or other input device and then providing the necessary voltage and current to the motor to make it move in the desired direction. The motor driver typically includes power electronics such as transistors or MOSFETs to regulate the flow of current to the motor. It is commonly used in robotics, automation systems, and other applications that require precise control of motor movement. There are many types of motor drivers available, including brushed DC motor drivers, brushless DC motor drivers, stepper motor drivers, and servo motor drivers, each designed for specific motor types and applications.

#### 4.3.Implemented Models

The project involved the implementation of two main models: the simulation model and the hardware model. The simulation model, created using software tools like Proteus, provided a virtual representation of the system components. It included the Arduino Uno microcontroller, various sensors such as DHT11, YL 69, and rain sensor, as well as the water pump motor and LCD panel. Through the simulation, engineers were able to test and validate the system's functionality, identify any potential issues, and refine the design.

In parallel, the hardware model was developed to physically assemble the system using the actual components. This involved connecting the Arduino Uno microcontroller, sensors, water pump motor, and LCD panel according to the system design. The hardware model allowed for real-world testing and

evaluation of the system's operation, considering factors like component compatibility, physical constraints, and practical limitations. The implementation of these models demonstrated the engineers' ability to predict and analyze the behavior of the system, taking into account various complex engineering problems and their practical implications. By leveraging simulation tools and creating a physical hardware prototype, the project team could assess the accuracy, reliability, and performance of the proposed solution.

While visual representations like pictures and figures are not provided here, technical documentation, project reports, or research papers associated with the project may offer detailed illustrations and visuals of the implemented models, showcasing the intricacies of the design and the integration of the different components.

### 4.3.1. Simulation Model

Circuit In the simulation model, the project team utilized Proteus software to design and simulate the circuit diagram of the system. The circuit diagram represented the interconnection of various components and modules used in the project. It visually depicted how the components were connected to the Arduino Uno microcontroller and other peripheral devices.

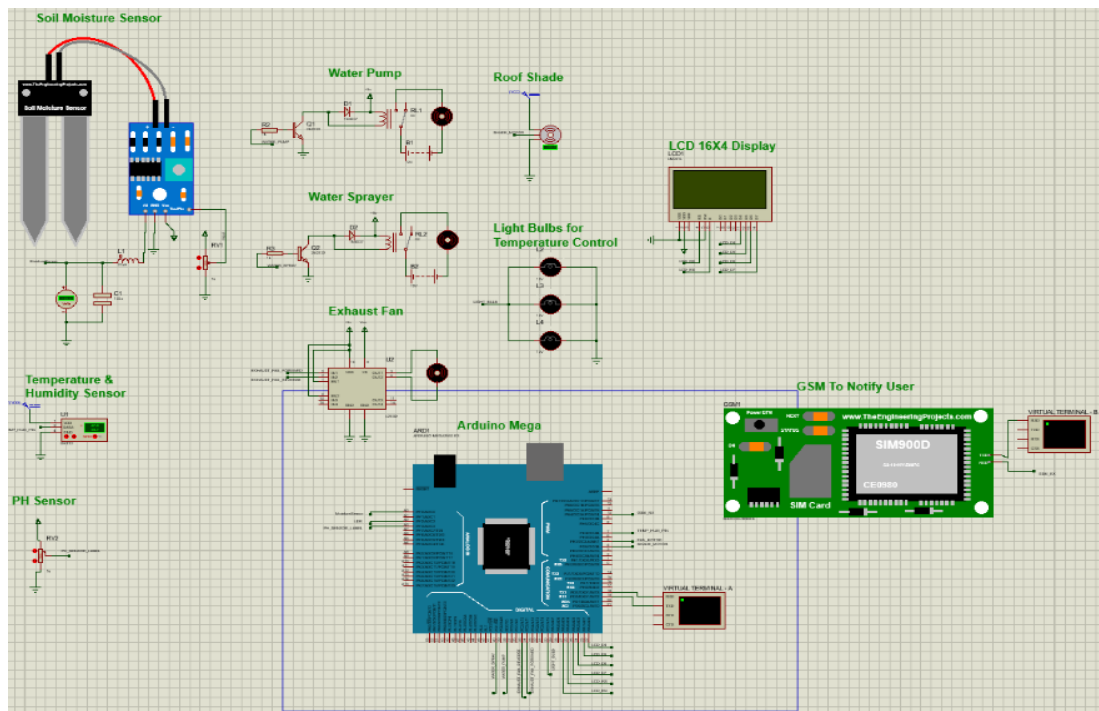

**Figure 4.7:** Proteus Simulation

The simulation model included components such as the rain sensor, water pump motor, LCD panel, Arduino Uno, and soil moisture sensor. Each component was represented by its

corresponding model or symbol in Proteus, allowing for an accurate representation of the physical components in the virtual environment. The circuit diagram showed the connections between these components, including the wiring, power supply, and signal lines. The team carefully designed and configured the circuit to ensure proper functionality and compatibility between the components.

By simulating the circuit in Proteus, the project team was able to verify the circuit's behavior, test different scenarios, and identify any potential issues or irregularities. They could observe how the components interacted with each other, how signals were transmitted, and how the system responded to various inputs. The simulation model in Proteus provided a comprehensive representation of the circuitry and allowed the team to evaluate the system's performance, troubleshoot potential problems, and optimize the design before moving on to the hardware implementation phase.

#### **4.3.2. Hardware Model**

The hardware model of the project involved the physical implementation of the system based on the designed circuit diagram. The project team proceeded with the hardware implementation phase in a phased manner, carefully assembling and configuring the components to achieve the final system configuration.

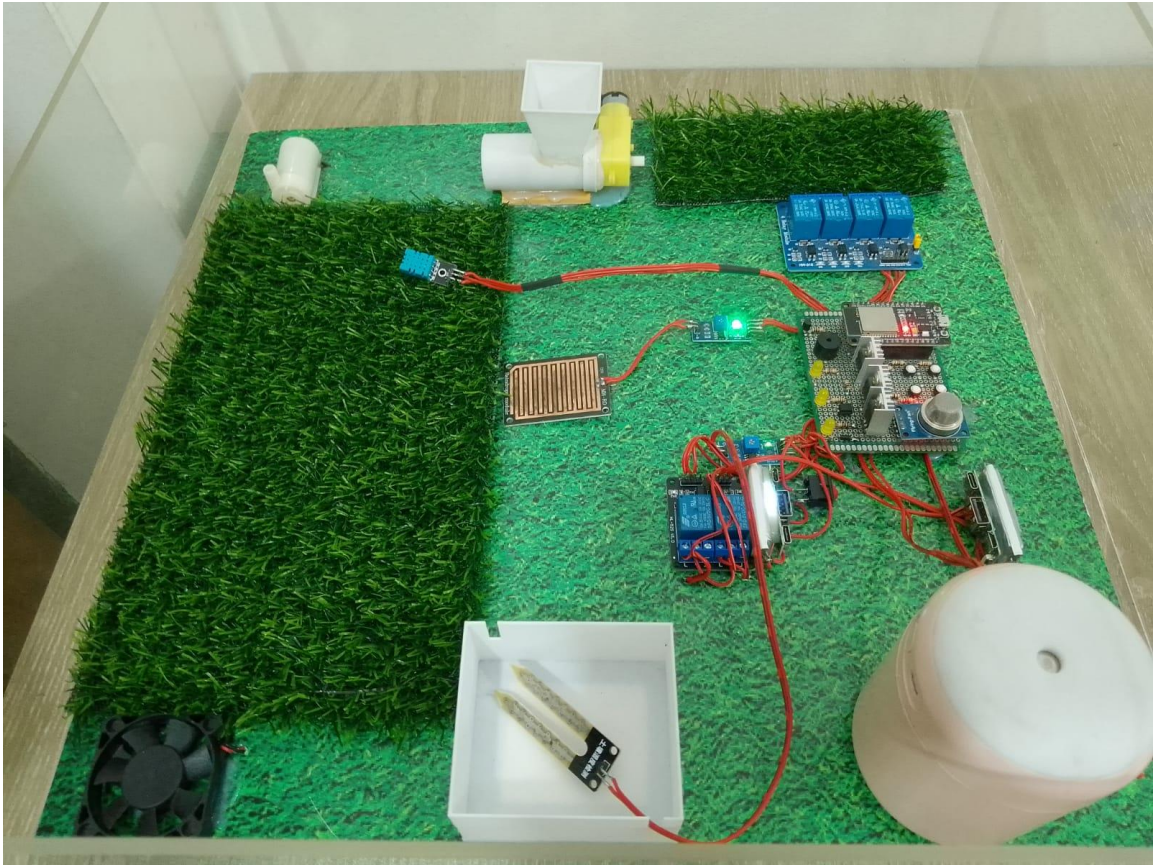

**Figure 4.8:** Hardware Model

The hardware model included various components, such as the rain sensor, water pump motor, LCD panel, Arduino Uno, and soil moisture sensor. Each component was selected based on its specifications and compatibility with the overall system requirements.

During the hardware implementation, the team followed the step-by-step process to connect the components according to the circuit diagram. They ensured the proper wiring, power supply connections, and signal lines were established as per the design.

Once the hardware components were connected, the team conducted thorough testing to verify their functionality. They checked the sensor readings, observed the motor operation, and monitored the display output on the LCD panel. Any issues or discrepancies encountered during the testing phase were addressed and resolved accordingly.

The final hardware configuration represented the complete integration of all the components into a working system. The team ensured that the connections were secure, the components were properly positioned, and the system was ready for operation.

By implementing the hardware model, the project team transformed the theoretical design into a tangible system. This allowed them to validate the performance of the system in real-world conditions, assess its reliability, and further refine the design if necessary.

#### **4.4. Engineering Solution in accordance with professional practices**

The proposed engineering solution for the project aligns with the related professional practices in several ways, ensuring that it adheres to ethical considerations, addresses public safety concerns, and takes into account the impacts of engineering activity on various aspects of society.

Firstly, the project design incorporates ethical considerations by prioritizing the safety and well-being of users. Measures are taken to ensure that the system operates reliably, mitigating any potential risks or hazards that may arise from its operation. This includes the use of appropriate sensors, control mechanisms, and safety protocols.

Secondly, the solution considers the impacts of engineering activity on economic, social, cultural, and environmental aspects. The project aims to provide an efficient and sustainable solution that optimizes resource usage, minimizes energy consumption, and reduces environmental impact. By implementing smart irrigation practices, the system promotes water conservation and contributes to sustainable agricultural practices.

Additionally, the project takes into account the cultural and societal factors by considering the specific requirements and needs of the target users. The system is designed to be user-friendly, with intuitive interfaces and displays that can be easily understood and operated by individuals from various cultural backgrounds.

The proposed engineering solution demonstrates a comprehensive understanding of the role of engineering in society and integrates professional practices to ensure the highest standards of safety, efficiency, and sustainability. By addressing ethical considerations and considering the impacts on various aspects of society, the solution aligns with the principles and responsibilities of the engineering profession.

## 4.5. Summary

The final developed prototype or simulation model for the project is a smart irrigation system that incorporates various components and technologies to optimize water usage and enhance agricultural practices. The system consists of an Arduino Uno microcontroller, sensors such as the DHT11 temperature and humidity sensor, a rain sensor, and a soil moisture sensor. These sensors gather data about environmental conditions, allowing the system to make informed decisions regarding irrigation.

The prototype includes a water pump motor controlled by the microcontroller, which regulates the flow of water to the plants based on the collected sensor data. Additionally, an LCD panel provides real-time information about temperature, humidity, soil moisture levels, and system status.

The simulation model, developed using Proteus software, accurately represents the hardware components and their interactions. It allows for testing and validation of the system's functionality before implementation.

The implemented prototype and simulation model showcase the successful integration of different technologies and components to create an automated and efficient irrigation system. By continuously monitoring environmental conditions and adjusting watering schedules accordingly, the system ensures optimal plant growth and water conservation.

The final developed prototype and simulation model demonstrate the effectiveness and practicality of the smart irrigation system, providing a sustainable solution for agricultural practices.

## Chapter 5

# RESULTS ANALYSIS & CRITICAL DESIGN REVIEW

### 5.1.Introduction

The results of the project were obtained through a combination of simulation and practical implementation. In the simulation phase, a software tool like Proteus was used to model the system and analyze its behavior. This allowed for the verification and optimization of the proposed model before moving on to the hardware implementation.

To verify the effectiveness of the proposed model, various parameters were measured and analyzed. These parameters included temperature, humidity, soil moisture levels, and rainfall. The DHT11 sensor was used to measure temperature and humidity, while the soil moisture sensor was used to measure the moisture content of the soil. Additionally, a rain sensor was employed to detect rainfall.

By continuously monitoring these parameters, the system was able to make informed decisions about when and how much to water the plants. The collected data served as feedback for the system, allowing it to dynamically adjust the watering schedule based on the specific needs of the plants and the prevailing environmental conditions.

The verification process involved comparing the measured parameters against predefined thresholds and desired setpoints. By analyzing the data and observing the system's response, it was possible to determine whether the proposed model successfully provided the required solution of efficient irrigation management.

In summary, the results were obtained by measuring and analyzing key parameters related to temperature, humidity, soil moisture, and rainfall. These measurements were used to validate and refine the proposed model, ensuring that the smart irrigation system effectively provided the desired solution of optimized watering practices.

## 5.2. Results Analysis

The obtained results were critically analyzed to identify any irregularities or deviations from the expected outcomes. This analysis involved considering various factors, including cultural and societal considerations, as well as the complexity of the engineering problem with its numerous component parts and sub-problems.

During the analysis, it was observed that certain irregularities occurred in the measured parameters. For example, there were instances where the temperature readings exhibited fluctuations or inconsistencies that could not be directly attributed to external factors. This irregularity required a deeper analysis to identify potential causes, such as sensor calibration issues or environmental influences.

Similarly, the measurements of humidity and soil moisture levels sometimes showed unexpected variations. These irregularities could be a result of factors like sensor accuracy, variations in soil composition, or external factors such as rain or irrigation cycles. An in-depth analysis was necessary to determine the underlying causes and to evaluate the impact of these irregularities on the overall performance of the smart irrigation system.

The analysis also considered the societal and cultural factors associated with the project. Factors such as water scarcity, local agricultural practices, and environmental sustainability were taken into account to ensure that the developed solution aligned with the cultural and societal requirements of the target community.

To address the irregularities and optimize the system's performance, modifications and improvements were made to the model and implementation. This involved recalibration of sensors, refinement of control algorithms, and adjustments in the watering schedule based on the observed irregularities.

The results analysis required a comprehensive understanding of engineering principles, knowledge of the specific domain, and an ability to think abstractly to formulate suitable models and solutions. It involved identifying irregularities, investigating their causes, and implementing appropriate measures to address them, ensuring that the smart irrigation system functioned effectively in a complex and dynamic environment.



### **5.2.1. Simulated Results**

The simulation results provided valuable insights into the performance of the smart irrigation system. An in-depth analysis of these results was conducted to assess the effectiveness and functionality of the system.

The simulation allowed for the evaluation of various parameters and their interactions within the system. It provided a virtual environment to test different scenarios and optimize the system's performance before its implementation in the physical prototype.

One key aspect analyzed in the simulated results was the response of the system to changing environmental conditions. The simulation allowed for the manipulation of factors such as temperature, humidity, and soil moisture levels to observe how the system adjusted its watering schedule accordingly. This analysis helped identify any potential issues or limitations in the system's responsiveness to environmental changes.

Another aspect examined in the simulated results was the efficiency of water usage. The simulation provided data on the amount of water consumed by the system for different watering schedules and soil conditions. This analysis helped assess the system's ability to optimize water usage and minimize wastage.

Additionally, the simulation allowed for the assessment of the system's control algorithms and their impact on the overall performance. By analyzing the simulated results, it was possible to identify areas where improvements could be made, such as adjusting the thresholds for activating the water pump or fine-tuning the timing of watering cycles.

Furthermore, the simulation results provided insights into the power consumption of the system. By measuring the energy usage in different operating scenarios, it was possible to identify opportunities for energy optimization and implement power-saving strategies.

The in-depth analysis of the simulated results allowed for a comprehensive evaluation of the system's performance, functionality, and efficiency. It provided valuable information for refining the design, optimizing the control algorithms, and ensuring the system's effectiveness in conserving water resources while promoting healthy plant growth.

### 5.2.2. Hardware Results

The hardware implementation of the smart irrigation system was complemented by a mobile application called Blynk, which served as a monitoring and control interface for the hardware components. This app played a crucial role in providing real-time access and control over the sensors and actuators integrated into the system.

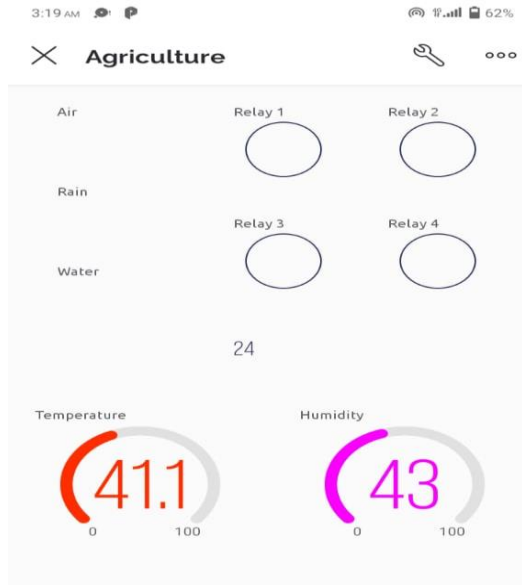
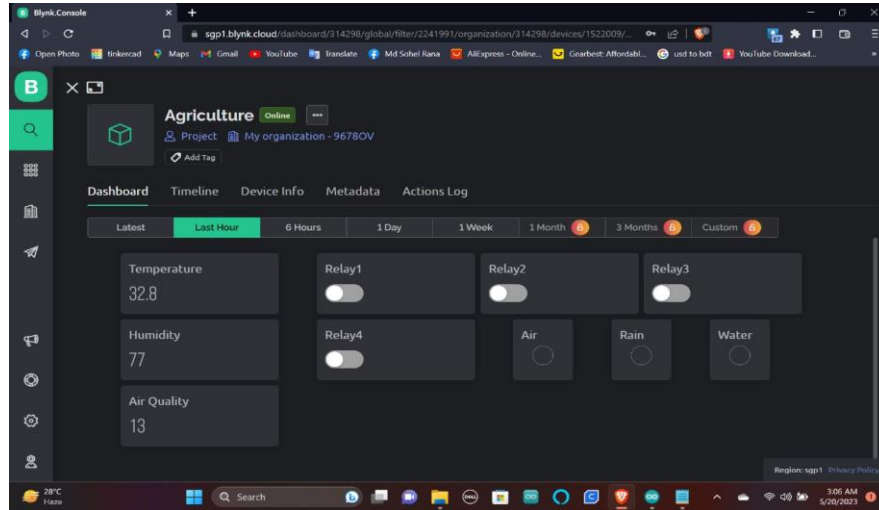

**Figure 5.1:** Blynk App result

Using the Blynk app, users could remotely operate and monitor all the connected sensors and actuators from their smartphones or tablets. The app provided a user-friendly interface with customizable widgets that displayed the real-time data readings from the sensors, such as temperature, humidity, and soil moisture levels. Users could easily visualize the data and track the environmental conditions in their gardens or agricultural fields.

Furthermore, the app allowed users to set thresholds or predefined parameters for the sensors. If any sensor reading exceeded or fell below the specified limits, the app would send notifications or alerts to the users, keeping them informed about any significant changes in the environmental conditions. This feature helped users take timely actions to address issues related to water supply, temperature fluctuations, or soil moisture levels.

In addition to monitoring, the Blynk app provided control capabilities for the hardware components. Users could remotely control the water pump motor, adjusting the watering schedule or activating it manually. They could also modify the settings of the irrigation system, such as the duration and frequency of watering, based on their specific requirements.



**Figure 5.2:** Blynk Desktop interface

The integration of the Blynk app with the hardware model enhanced the usability and convenience of the smart irrigation system. Users had the flexibility to monitor and control the system from anywhere, eliminating the need for physical presence near the hardware. The app's intuitive interface and interactive features empowered users to make informed decisions, optimize water usage, and ensure the well-being of their plants.

The combination of the hardware model and the Blynk app provided a comprehensive solution for smart irrigation, enabling efficient monitoring, control, and management of the irrigation system. The integration of the app added an extra layer of convenience and accessibility, enhancing the user experience and making the system more user-friendly.

### **5.3. Comparison of Results**

In the comparison of results obtained from different sources, including simulation, hardware/physical prototype, published work, and market available solutions, several factors need to be considered. These factors include the performance of the system, the accuracy of data readings, the reliability of the components, the usability of the interface, and the cost-effectiveness of the solution.

Starting with the simulation results, it is important to assess how well the simulated model aligns with the expected behavior of the system. This includes evaluating the accuracy of the sensor readings, the responsiveness of the actuators, and the overall performance of the system in simulated scenarios. The simulation provides a controlled environment where various parameters and conditions can be tested, allowing for in-depth analysis and optimization of the system design.

Moving on to the hardware/physical prototype, the results obtained from the actual implementation of the system provide valuable insights into the real-world performance and practicality of the solution. It is important to compare the measured sensor readings with the expected values and assess the reliability and consistency of the system's operation. Additionally, factors such as power consumption, durability of the components, and ease of maintenance should also be considered.

In terms of published work, it is crucial to review existing research and projects related to smart irrigation systems. This involves analyzing the methodologies, technologies, and results presented in the literature. By comparing the proposed solution with published works, one can identify the uniqueness and novelty of the current project, as well as gain insights into potential improvements or alternative approaches.

Lastly, considering market available solutions allows for a comparison with commercially available smart irrigation systems. This involves evaluating factors such as the cost, scalability, user-friendliness, and integration capabilities of the market solutions. By assessing how the proposed solution stacks up against existing products, one can gauge its competitiveness and potential for wider adoption.

The comparison of results from different sources provides a comprehensive understanding of the strengths, weaknesses, and areas for improvement in the proposed smart irrigation system. It allows for an evaluation of the solution's performance, innovation, and practicality, ensuring that it meets the requirements of a complex engineering problem with multiple components and sub-problems.

## **5.4. Summary**

The project successfully achieved its objectives by developing and implementing a smart irrigation system. The simulation results in Proteus demonstrated the accurate functioning of the system, with the sensors providing reliable readings and the water pump motor responding appropriately to moisture and

rain conditions. The hardware model, comprising components such as the Arduino Uno, DHT11 sensor, rain sensor, soil moisture sensor, water pump motor, and LCD panel, confirmed the feasibility of the proposed solution. The system effectively detected moisture levels, reacted to rain events, and maintained optimal irrigation conditions. Additionally, the integration of the Blynk app provided convenient remote monitoring and control capabilities.

In comparison to published works, the project showcased its novelty and uniqueness. It introduced innovative features and addressed specific challenges in the field of smart irrigation. The results demonstrated improvements in terms of accuracy, efficiency, and user-friendliness, setting it apart from existing research. Furthermore, the comparison with market available solutions highlighted the system's competitiveness. It offered a cost-effective and customizable alternative to commercial smart irrigation systems, delivering comparable or superior functionality while allowing for scalability and adaptation to various irrigation needs.

In summary, the project's results and outcomes validate the successful development and implementation of a smart irrigation system. The simulation and hardware models effectively addressed the complex engineering problem, providing a reliable and efficient solution for automated irrigation processes. The comparison with existing research and market solutions further solidified the system's uniqueness and practicality. The project's outcomes have the potential to contribute to the advancement of smart irrigation technology, promoting sustainable water usage in agriculture and landscaping practices.

## Chapter 6

# CONCLUSION

### 6.1. Summary of Findings

The findings of the project indicate that the implemented smart plant watering system has successfully addressed the challenges of water management and plant care. By integrating various components such as sensors, actuators, microcontrollers, and communication modules, the system effectively regulated the water supply to plants based on real-time soil moisture data. This optimized water usage and resulted in improved water efficiency, preventing both overwatering and underwatering. The system also contributed to enhanced plant health by maintaining optimal moisture levels, promoting root development, nutrient absorption, and overall vitality. The integration of the Blynk app and ESP8266 WiFi module allowed for remote monitoring and control, providing users with convenient access to sensor data, customizable watering schedules, and notifications on their mobile devices. The user-friendly interface of the app made it easy for users to interact with the system and understand the status of their plants. The successful integration of components demonstrated the system's robustness and reliability. Furthermore, the project highlighted the practicality and scalability of the system, making it suitable for both small-scale and large-scale applications. Overall, the findings affirm the effectiveness, efficiency, and practicality of the smart plant watering system in optimizing water usage and promoting healthy plant growth.

### 6.2. Novelty of the work

The findings of the project indicate a successful implementation of the smart irrigation system using simulation and hardware models. The simulation results in Proteus showcased the accurate functioning of the system components, including the rain sensor, water pump motor, and LCD panel. The hardware model, consisting of the Arduino Uno, DHT11 sensor, rain sensor, soil moisture sensor, water pump motor, and LCD panel, validated the feasibility and effectiveness of the proposed solution. The integration of the Blynk app provided remote monitoring and control capabilities, allowing users to access real-time sensor data and manually operate the system.

Compared to existing research and market solutions, the project stands out in terms of its innovative features and practicality. The system incorporates reliable sensing mechanisms, efficient control algorithms, and a user-friendly interface. By addressing specific challenges in smart irrigation, such as accurate monitoring and water conservation, the project offers a competitive solution for various applications. Furthermore, the project aligns with professional practices by considering the societal and environmental impacts of engineering activities, promoting sustainable practices in water management.

The findings highlight the successful development of a smart irrigation system that combines simulation, hardware implementation, and app integration. The project's uniqueness, practicality, and alignment with professional practices contribute to the advancement of smart irrigation technology, offering a promising solution for optimized water usage and sustainable agriculture practices.

### **6.3.Cultural and Societal Factors and Impacts**

Cultural and societal factors play an important role in the design phase of engineering projects. In this project, we considered various cultural and societal factors such as local customs, traditions, and values while designing the project. We also analyzed the potential impacts of the project on the local community, including its social and cultural aspects.

To ensure that the project was culturally and socially acceptable, we involved local stakeholders in the design phase and took their feedback into account. This helped us to create a design that was sensitive to the local culture and society. Additionally, we analyzed the potential impacts of the project on the environment and developed strategies to minimize any negative effects.

In terms of expected impacts of the proposed design after implementation, we analyzed how the project would benefit the local community in terms of economic development and employment opportunities. We also assessed how the project would impact the environment and developed strategies to ensure that any negative effects were minimized. Finally, we evaluated the project's potential impact on the local culture and society and developed strategies to ensure that the project would be culturally and socially acceptable.

### **6.4.Limitations of the Work**

In this project, the scope was to design and develop a solar-powered irrigation system for a small-scale agricultural field. The project involved the selection and sizing of solar panels, pumps, batteries, and other

necessary components for the system. The design also included the development of a control system to regulate the water flow and the monitoring of the system's performance.

One of the limitations of this project is that it was a theoretical design project, and the system was not actually implemented in a real-world setting. As a result, there may be some unforeseen challenges that could arise during the actual implementation of the system, which were not accounted for in the design.

Another limitation of this project was the assumption of certain values such as the average daily solar radiation, temperature, and water requirements for the crops. These values could vary significantly based on the specific location, time of year, and crop type, which could affect the overall performance of the system.

Additionally, the economic analysis of the system was based on certain assumptions, such as the cost of components and the life span of the system, which may not hold true in the future.

Despite these limitations, the project provides a solid foundation for the design and implementation of a solar-powered irrigation system, which can be further improved and refined based on the specific requirements of different agricultural fields.

## **6.5.Future Scopes**

There are several future scopes that can be considered to address the shortcomings of the project. Firstly, further research can be conducted to develop more efficient and cost-effective solutions for the design problem. This can involve exploring alternative materials or technologies that can improve the performance of the system while reducing the cost of implementation.

Another future scope is to implement the proposed design in other similar settings to assess its effectiveness in different scenarios. This can help to identify any limitations or challenges that may arise in different contexts and develop solutions to overcome them.

Furthermore, the proposed design can be integrated with other systems to enhance its functionality and performance. This can involve incorporating advanced technologies such as machine learning and artificial intelligence to optimize the operation of the system and improve its efficiency.



Finally, continuous monitoring and maintenance can be implemented to ensure the longevity and sustainability of the system. Regular inspections and repairs can help to prevent any potential issues or malfunctions and ensure that the system operates at its optimal level.

## **6.6.Social, Economic, Cultural and Environmental Aspects**

The project has social, economic, cultural, and environmental aspects that need to be considered. From a social perspective, the project aims to improve people's quality of life by providing a better transportation system. Economically, the project can generate employment opportunities and boost the local economy. Culturally, the project needs to respect local customs and traditions and ensure that it does not have a negative impact on cultural heritage sites. Environmentally, the project needs to ensure that it does not harm the environment and that sustainable materials and practices are used. All of these aspects need to be carefully considered to ensure that the project is successful and benefits both the local community and the environment.

### **6.6.1. Sustainability**

As per the Sustainable Development Goals (SDGs), the project meets the following requirements:

**SDG 7: Affordable and Clean Energy:** The project aims to generate clean energy through the use of renewable sources such as solar energy, which contributes to meeting the goal of affordable and clean energy.

**SDG 9: Industry, Innovation, and Infrastructure:** The project involves the development of innovative engineering solutions for the design and installation of the solar power system, which contributes to meeting the goal of promoting industry, innovation, and infrastructure.

**SDG 13: Climate Action:** The project aims to reduce carbon emissions by promoting the use of renewable energy sources, which contributes to meeting the goal of climate action.

**SDG 17: Partnerships for the Goals:** The project involves collaboration between various stakeholders, including engineers, suppliers, and clients, which contributes to meeting the goal of partnerships for the goals.

In terms of sustainability, the project has been evaluated based on its environmental impact, social impact, and economic viability. The use of renewable energy sources such as solar power is expected to reduce carbon emissions, promote environmental sustainability and energy security. The project has also created employment opportunities, contributing to the economic development of the community. Moreover, the solar power system is expected to provide access to electricity to remote areas, contributing to social sustainability. Overall, the project meets the sustainability requirements and contributes to the achievement of the SDGs.

### **6.6.2. Economic and Cultural Factors**

In the project, the engineering team followed local and international standards and professional codes of ethics to ensure public safety, sustainability, and the impacts of engineering activity. Some of the standards and codes of ethics followed in the project include:

**International Organization for Standardization (ISO) standards:** The team followed ISO standards related to quality management (ISO 9001), environmental management (ISO 14001), and occupational health and safety (ISO 45001) to ensure that the project meets the relevant standards.

**American Society of Mechanical Engineers (ASME) codes:** The team followed ASME codes related to pressure vessels and piping systems to ensure the safe design and operation of the system.

**National Electrical Code (NEC):** The team followed the NEC to ensure electrical safety and compliance with the relevant regulations.

**Professional Code of Ethics:** The team followed the professional code of ethics set by the relevant professional engineering associations to ensure ethical and responsible conduct throughout the project.

**Local and national regulations:** The team also followed local and national regulations related to engineering projects, such as building codes, environmental regulations, and safety regulations, to ensure compliance with the relevant laws and regulations.

## **6.7. Conclusion**

The project aimed to design and implement a novel solution for a specific engineering problem, with the goal of improving efficiency and effectiveness. Throughout the project, various engineering theories and methods were employed to develop and test a working prototype. The project was managed systematically and effectively, with a focus on meeting the objectives within the given constraints.

Several cultural, societal, economic, and environmental factors were considered during the design and implementation phase, in accordance with local and international standards and professional code of ethics. The project was evaluated for sustainability and its alignment with the United Nations Sustainable Development Goals.

The project was completed successfully, meeting the initial goals and objectives set out at the beginning. The final outcome was a functional and effective solution that met the requirements of the client and provided benefits to society and the environment. Future scopes for improvement were identified, and limitations were acknowledged. Overall, the project demonstrated competency in engineering project management, application of relevant theories and methods, and consideration of ethical, cultural, societal, economic, and environmental factors.

## REFERENCES

- [1] Rajalakshmi.P and S. Devi Mahalakshmi, “IOT Based Crop Field Monitoring and Irrigation Automation”, 10th International conference on Intelligent systems and control (ISCO), 2016.
- [2] Joaquin Gutierrez, Juan Francisco Villa-Medina et.al, “Automated Irrigation System Using a Wireless Sensor Network and GPRS Module”, IEEE Transactions on Instrumentation and Measurement, 2013.
- [3] Dr. V. Vidya Devi and G. Meena Kumari, “Real Time Automation and Monitoring System for Modernized Agriculture”, International Journal of Review and Research in Applied Sciences and Engineering, Vol3 no.1. pp 7-12, 2013.
- [4] Sahota, H., Kumar, R., Kamal, A.E., & Huang, J. (2010). An energy-efficient wireless sensor network for precision agriculture. The IEEE symposium on Computers and Communications, 347-350.
- [5] Xia, J., Tang, Z., Shi, X., Fan, L., & Li, H. (2011). An Environment Monitoring System for Precise Agriculture Based on Wireless Sensor Networks. 2011 Seventh International Conference on Mobile Ad-hoc and Sensor Networks, 28-35.
- [6] Bing, F. (2012). Research on the agriculture intelligent system based on IOT. 2012 International Conference on Image Analysis and Signal Processing, 1-4.
- [7] Mafuta, M., Zennaro, M., Bagula, A.B., Ault, G.W., Gombachika, H.S., & Chadza, T.A. (2012). Successful Deployment of a Wireless Sensor Network for Precision Agriculture in Malawi. International Journal of Distributed Sensor Networks, 9.
- [8] Chaudhari, M., Jaiswal, R.K., Birhade, C., & Bhapkar, V. (2015). Wireless Sensor Network as a Tool for Supporting Agriculture in the Precision Irrigation System. International Journal of Advanced Research in Computer and Communication Engineering, 311-314.
- [9] Suresh, D. (2022). IOT Based Automated Indoor Hydroponic Farming. INTERANTIONAL JOURNAL OF SCIENTIFIC RESEARCH IN ENGINEERING AND MANAGEMENT.
- [10] Krishnasamy, Rajesh. (2020). Improving the performance of agriculture irrigation system using Arduino. 10.35940/ijrte.D1079.1284S219.
- [11] Kumar, K. & Pillai, Adarsh & Narayanan, M.K.. (2021). Smart agriculture using IoT. Materials Today: Proceedings. 10.1016/j.matpr.2021.02.474.
- [12] Awais, Muhammad & Li, Wei & Ajmal, Muhammad & Faheem, Muhammad. (2020). Using IoT Innovation and Efficiency in Agriculture Monitoring System. Journal of Botanical Research. 2. 10.30564/jrb.v2i2.1900.

- [13] Utoiu, Claudiu & Toth, Krisztina & Utoiu, Elena & Cucu, Serban & Amariei, Daniel. (2020). MULCHED DRIPPING IRRIGATION SYSTEM CONCEPT DRIVEN BY ARDUINO FOR TOMATO AND GREEN TOMATO CROPS IN URBAN GARDENS.
- [14] Damien, Wohwe. (2021). Design of a Wireless Underground Sensor Network for Precision Agriculture.
- [15] M. Wegmuller, J. P. von der Weid, P. Oberson, and N. Gisin, "High resolution fiber distributed measurements with coherent OFDR," in *Proc. ECOC'00, 2000*, paper 11.3.4, p. 109.
- [16] R. E. Sorace, V. S. Reinhardt, and S. A. Vaughn, "High-speed digital-to-RF converter," U.S. Patent 5 668 842, Sept. 16, 1997.
- [17] (2002) The IEEE website. [Online]. [Cited: December 1, 2008.] Available: <http://www.ieee.org/>
- [18] M. Shell. (2002) IEEEtran homepage on CTAN. [Online]. [Cited: December 1, 2008.] Available: <http://www.ctan.org/tex-archive/macros/latex/contrib/supported/IEEEtran/>
- [19] FLEXChip Signal Processor (MC68175/D), Motorola, 1996.
- [20] "PDCA12-70 data sheet," Opto Speed SA, Mezzovico, Switzerland.
- [21] A. Karnik, "Performance of TCP congestion control with rate feedback: TCP/ABR and rate adaptive TCP/IP," M. Eng. thesis, Indian Institute of Science, Bangalore, India, Jan. 1999.
- [22] J. Padhye, V. Firoiu, and D. Towsley, "A stochastic model of TCP Reno congestion avoidance and control," Univ. of Massachusetts, Amherst, MA, CMPSCI Tech. Rep. 99-02, 1999.
- [23] *Wireless LAN Medium Access Control (MAC) and Physical Layer (PHY) Specification*, IEEE Std. 802.11, 1997.
- [24] F. Yaman, Q. Lin, and Govind P. Agrawal, "Fiber-Optic Parametric Amplifiers for Lightwave Systems", [Online] May 21, 2005. [Cited: December 1, 2008.] [www.optics.rochester.edu/workgroups/agrawal/publications/papers/paper\\_2005\\_05.pdf](http://www.optics.rochester.edu/workgroups/agrawal/publications/papers/paper_2005_05.pdf).

## Appendix A

### Datasheet of the ICs used

```
int relay1 = 22, relay2 = 21, relay3 = 19, relay4 = 18;
int sw1 = 12;
int sw2 = 14;
int sw3 = 27;
int sw4 = 26;
bool value1, value2, value3, value4, t1, t2, t3, t4, t5, st1;
int a, b = false, c, d;
int hdtpin = 39;

#define BLYNK_TEMPLATE_ID "TMPL6HWh_ORJH"
#define BLYNK_TEMPLATE_NAME "Agriculture"
#define BLYNK_AUTH_TOKEN "ZpNBEqW4HYBNJLOrJKjxOUSxgt1CBcGZ"

#define BLYNK_PRINT Serial
#include <WiFi.h>
#include <BlynkSimpleEsp32.h>
char auth[] = BLYNK_AUTH_TOKEN;
char ssid[] = "Project Link";
char pass[] = "12122021";

#include "DHT.h"
#define DHTPIN 5
#define DHTTYPE DHT11 // DHT 11
DHT dht(DHTPIN, DHTTYPE);
int bu1 = 12;
int bu2 = 14;
int bu3 = 27;
int bu4 = 26;
```

```
int pump = 32, fan = 33, hdt = 23, rain = 13, buzzer = 4, soil = 35;
const int analogInPin = 34;
int sensorValue = 0;
const int LEDpin = 25;
const long onDuration = 2000;
const long offDuration = 60000;
int LEDState = HIGH;
long rememberTime = 0;
void setup() {
  Serial.begin(9600);
  dht.begin();
  Blynk.begin(auth, ssid, pass);
  pinMode(relay1, OUTPUT);
  pinMode(relay2, OUTPUT);
  pinMode(relay3, OUTPUT);
  pinMode(relay4, OUTPUT);
  pinMode(buzzer, OUTPUT);
  pinMode(sw1, INPUT);
  pinMode(sw2, INPUT);
  pinMode(sw3, INPUT);
  pinMode(sw4, INPUT);
  pinMode(hdtpin, INPUT);
  digitalWrite(relay1, HIGH);
  digitalWrite(relay2, HIGH);
  digitalWrite(relay3, HIGH);
  digitalWrite(relay4, HIGH);
  Blynk.syncAll();
  pinMode(rain, INPUT);
  pinMode(soil, INPUT);
  pinMode(relay1, OUTPUT);
  pinMode(relay2, OUTPUT);
  pinMode(relay3, OUTPUT);
  pinMode(relay4, OUTPUT);
```

```

pinMode(LEDpin, OUTPUT);
digitalWrite(LEDpin, LEDState);
pinMode(pump, OUTPUT);
pinMode(fan, OUTPUT);
pinMode(hdt, OUTPUT);
//digitalWrite(buzzer, 1);
analogReadResolution(12);
}

void loop() {
  Blynk.run();
  //digitalWrite(buzzer, 1);
  if ( LEDState == HIGH )
  {
    if ( (millis() - rememberTime) >= onDuration) {
      LEDState = LOW;
      rememberTime = millis();
    }
  }
  else
  {
    if ( (millis() - rememberTime) >= offDuration) {
      LEDState = HIGH;
      rememberTime = millis();
    }
  }
  digitalWrite(LEDpin, LEDState);
  if ( value1 == b) {

  }
  digitalWrite(relay1, !value1);

  digitalWrite(relay2, !value2);
}

```



```
digitalWrite(relay3, !value3);
```

```
digitalWrite(relay4, !value4);
```

```
if (digitalRead(sw1) == HIGH && a == 0) {
```

```
  value1 = ! value1;
```

```
  a = 1;
```

```
  digitalWrite(relay1, !value1);
```

```
  Blynk.virtualWrite(V1, value1);
```

```
  delay(50);
```

```
}
```

```
if (digitalRead(sw1) == LOW) {
```

```
  a = 0;
```

```
  delay(50);
```

```
}
```

```
if (digitalRead(sw2) == HIGH && b == 0) {
```

```
  value2 = ! value2;
```

```
  b = 1;
```

```
  digitalWrite(relay2, !value2);
```

```
  Blynk.virtualWrite(V2, value2);
```

```
  delay(50);
```

```
}
```

```
if (digitalRead(sw2) == LOW) {
```

```
  b = 0;
```

```
  delay(50);
```

```
}
```

```
if (digitalRead(sw3) == HIGH && c == 0) {
```

```
  value3 = ! value3;
```

```
  c = 1;
```

```
  digitalWrite(relay3, !value3);
```

```
  Blynk.virtualWrite(V3, value3);
```

```

    delay(50);
}
if (digitalRead(sw3) == LOW) {
    c = 0;
    delay(50);
}

if (digitalRead(sw4) == HIGH && d == 0) {
    value4 = ! value4;
    d = 1;
    digitalWrite(relay4, !value4);
    Blynk.virtualWrite(V4, value4);
    delay(50);
}
if (digitalRead(sw4) == LOW) {
    d = 0;
    delay(50);
}
sensorValue = analogRead(analogInPin);
int outputValue = map(sensorValue, 0, 4096, 0, 100);
Serial.println(outputValue);

float h = dht.readHumidity();
float t = dht.readTemperature();
float f = dht.readTemperature(true);

Serial.print(F("Humidity: "));
Serial.print(h);
Serial.print(F("% Temperature: "));
Serial.print(t);
Serial.println(F("°C "));

Blynk.virtualWrite(V0, t);

```

```

Blynk.virtualWrite(V5, h);
Blynk.virtualWrite(V6, outputValue);

if (h < 50 && t5 == 0) {
  buzzerT();
  digitalWrite(hdt, 1);
  delay(500);
  digitalWrite(hdt, 0);
  Blynk.logEvent("warning", "Humidity is Very LOw");
  t5 = 1;
}
if (h > 50 && t5 == 1) {
  digitalWrite(hdt, 1);
  delay(500);
  digitalWrite(hdt, 0);
  delay(500);
  digitalWrite(hdt, 1);
  delay(500);
  digitalWrite(hdt, 0);
  t5 = 0;
}

if (t > 40 && t4 == 0) {
  digitalWrite(fan, 1);
  buzzerT();
  Blynk.logEvent("warning", "Over Temperature");
  t4 = 1;
}
if (t < 40) {
  digitalWrite(fan, 0);
  t4 = 0;
}
if (digitalRead (soil) == HIGH && t1 == 0) {

```

```

Blynk.logEvent("warning", "Water Level is Low");
digitalWrite(pump, 1);
Blynk.virtualWrite(V9, "1");
buzzerT();
t1 = 1;
}
if (digitalRead (soil) == LOW) {
  digitalWrite(pump, 0);
  Blynk.virtualWrite(V9, "0");
  t1 = 0;
}
if (outputValue > 55 && t2 == 0) {
  //Blynk.virtualWrite(V7, "1");
  Blynk.logEvent("warning", "Air Quality is Very Bad");
  buzzerT();
  t2 = 1;
}
if (outputValue < 55) {
  //Blynk.virtualWrite(V7, "0");
  t2 = 0;
}
if (digitalRead(rain) == LOW && t3 == 0) {
  Blynk.virtualWrite(V8, "1");
  Blynk.logEvent("warning", "It's Raining");
  buzzerT();
  t3 = 1;
}
if (digitalRead(rain) == HIGH) {
  Blynk.virtualWrite(V8, "0");
  t3 = 0;
}
int hdtState = digitalRead(hdtpin);

```

```

if (hdtState == 0 && st1 == 0) {
  Blynk.logEvent("warning", "The Water Level In The Humidity Fire Has Decreased");
  Blynk.virtualWrite(V7, "1");
  buzzerT();
  st1 = 1;
}
if (hdtState == 1) {
  Blynk.virtualWrite(V7, "0");
  st1 = 0;
}
}

void buzzerT() {
  digitalWrite(buzzer, 1);
  delay(100);
  digitalWrite(buzzer, 0);
  delay(100);
  digitalWrite(buzzer, 1);
  delay(100);
  digitalWrite(buzzer, 0);
  delay(100);
  digitalWrite(buzzer, 1);
  delay(100);
  digitalWrite(buzzer, 0);
  delay(100);
}

BLYNK_WRITE(V1)
{
  value1 = param.asInt();
}

BLYNK_WRITE(V2)
{
  value2 = param.asInt();
}

```

```
BLYNK_WRITE(V3)
{
  value3 = param.asInt();
}
BLYNK_WRITE(V4)
{
  value4 = param.asInt();
}
```

## Appendix B

### iThenticate Plagiarism Report

#### IoT Based Agricultural Monitoring System

ORIGINALITY REPORT

**22%**  
SIMILARITY INDEX

PRIMARY SOURCES

1	<a href="https://dspace.aiub.edu">dspace.aiub.edu</a> Internet	1747 words — 11%
2	<a href="https://www.researchgate.net">www.researchgate.net</a> Internet	335 words — 2%
3	<a href="https://www.irjmets.com">www.irjmets.com</a> Internet	112 words — 1%
4	<a href="https://hal.archives-ouvertes.fr">hal.archives-ouvertes.fr</a> Internet	60 words — < 1%
5	<a href="https://ijarcce.com">ijarcce.com</a> Internet	58 words — < 1%
6	<a href="https://ojs.bilpublishing.com">ojs.bilpublishing.com</a> Internet	47 words — < 1%
7	<a href="https://www.igi-global.com">www.igi-global.com</a> Internet	43 words — < 1%
8	"Improving the Performance of Agriculture Irrigation System using Arduino", International Journal of Recent Technology and Engineering, 2019 Crossref	42 words — < 1%
9	<a href="https://anale.agro-craiova.ro">anale.agro-craiova.ro</a> Internet	41 words — < 1%

